

— optipro™ —

Range of Distribution Boards



Complete Solution

Ever since the Optipro MCB was launched, it has been appreciated by customers. This gives us the opportunity to introduce to you another range - the Optipro Distribution Board. The product offers you a total solution with unmatched quality & safety at the right price making it, All That You Need.

IndoAsian's ideal of frugal engineering is the assurance of high quality products; a brand of Indian origin that has catered to the market for more than five decades.

**The
Range**

**The
Quality**

**The
Right
Deal**

Wide Range

The Optipro range is a complete and thought-through range of Distribution Boards with SPN, TPN, VTPN, Flexi, 7 segment, phase selector, enclosures and plug & socket types. This range single-handedly answers all your project needs.



Total Safety

True IP43 in its segment

Degree of protection in double door DBs is IP43.
The design is tested as per IEC 60529 for the IP test.
The true IP43 design makes the range suitable for all situations that demand IP43 degree of protection.

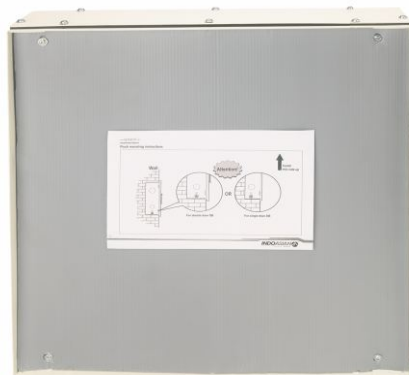

Cement protector

A specially-designed cement protector does not allow cement, dust etc. to enter the DB during construction. Once construction is complete, the cement protector can be easily removed to wire, keeping your DB free from dust and damage.

Isolated neutral bar

Once installed, the neutral bar on the Optipro Distribution Board is completely isolated from the box. It is neither visible nor is it accessible to human touch, offering complete protection against the live parts.

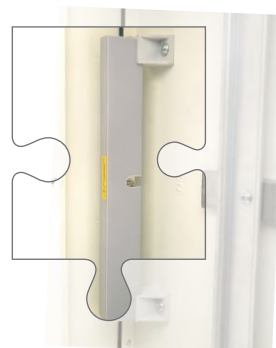

Simple Look

Fresh design

Thanks to its sleek and minimal look, the Optipro Distribution Board can look great on any wall. Its fresh and innovative design has truly transformed Distribution Boards for the future.



Innovative door knob

The knob of the Distribution Board is unique in design to meet all operational needs.

The knob is sleek with less projection off the surface. The innovative sliding mechanism grants it a longer life.



New colour & finish

Optipro Distribution Boards come in a new exciting colour that goes well with any decor. The matte finish of the product makes it match well with any wall texture. The finish does not attract dust and keeps the exterior clean.



Plain corners

The Optipro range is engineered to have no sharp edges. Thus, your hand will glide only over smooth and plain corners when you interact with the product, giving you a safe and stylish Distribution Board.



Ease of Use

Independent shield

The Optipro Distribution Board has an independent shield that is removable when necessary. During maintenance, the shield can be removed, while the door and frame remain in place. This makes operation fast and easy.

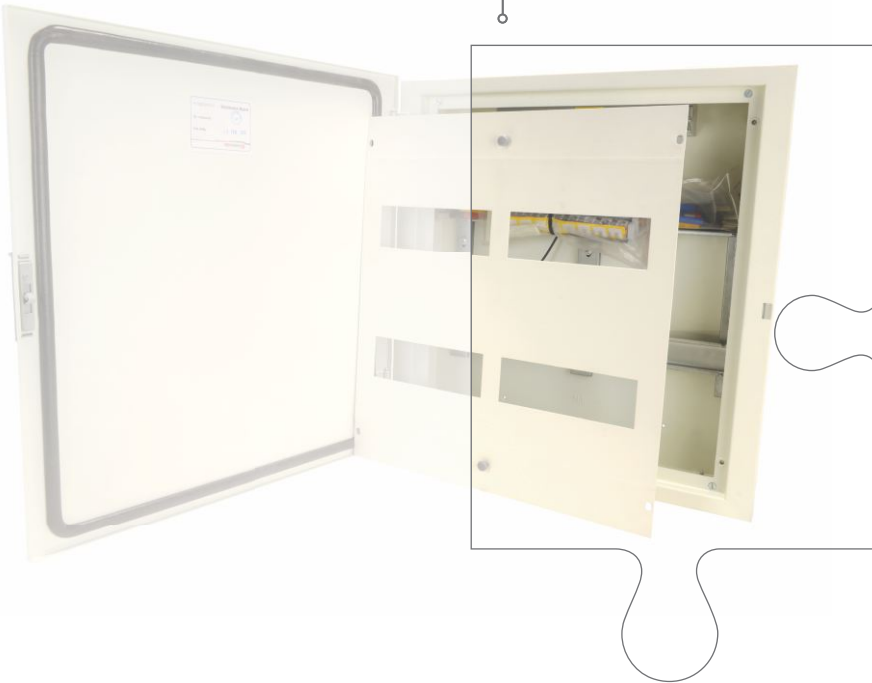

Box separately packed

Optipro presents the concept of twin packaging. Parts like the frame, shield and door are packed separately from the box. Thanks to this insight, installation is made easier for the user. The frame, shield and door can be safely stored until complete wiring and painting is done.

Dimensions

SPN DB Single door

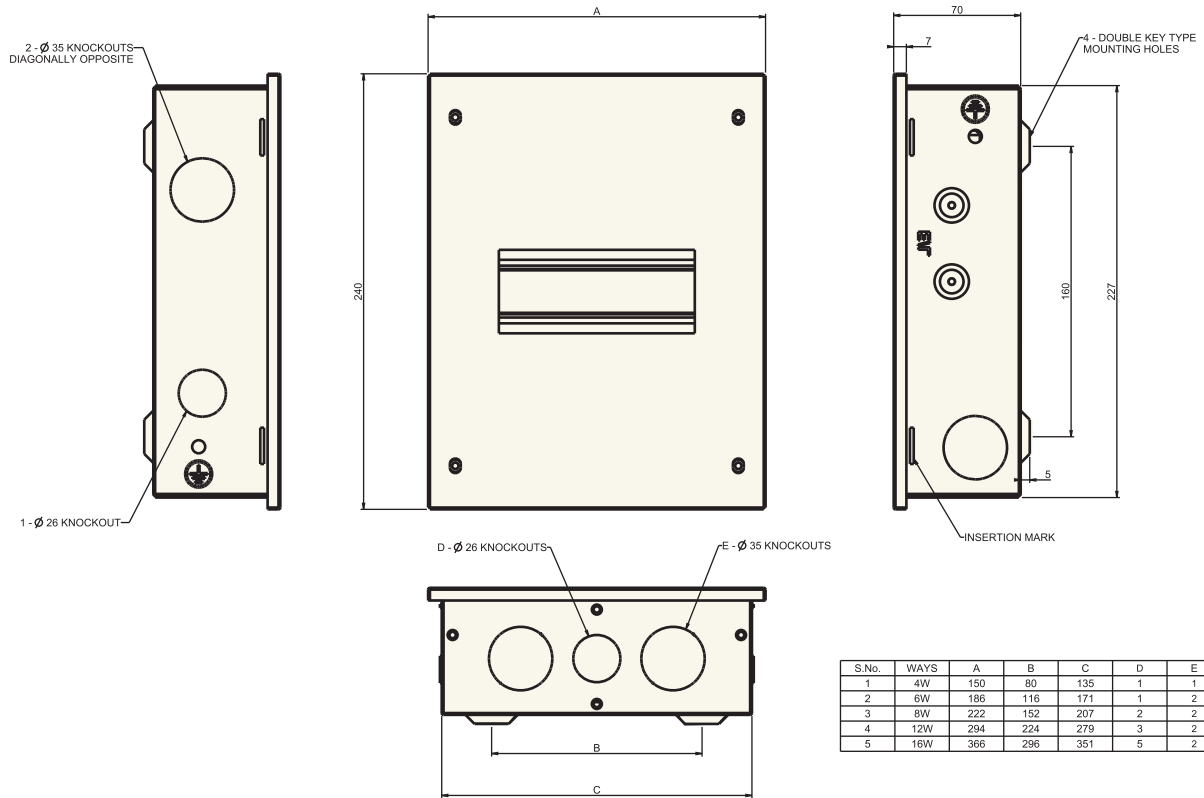

SPN DB Double door

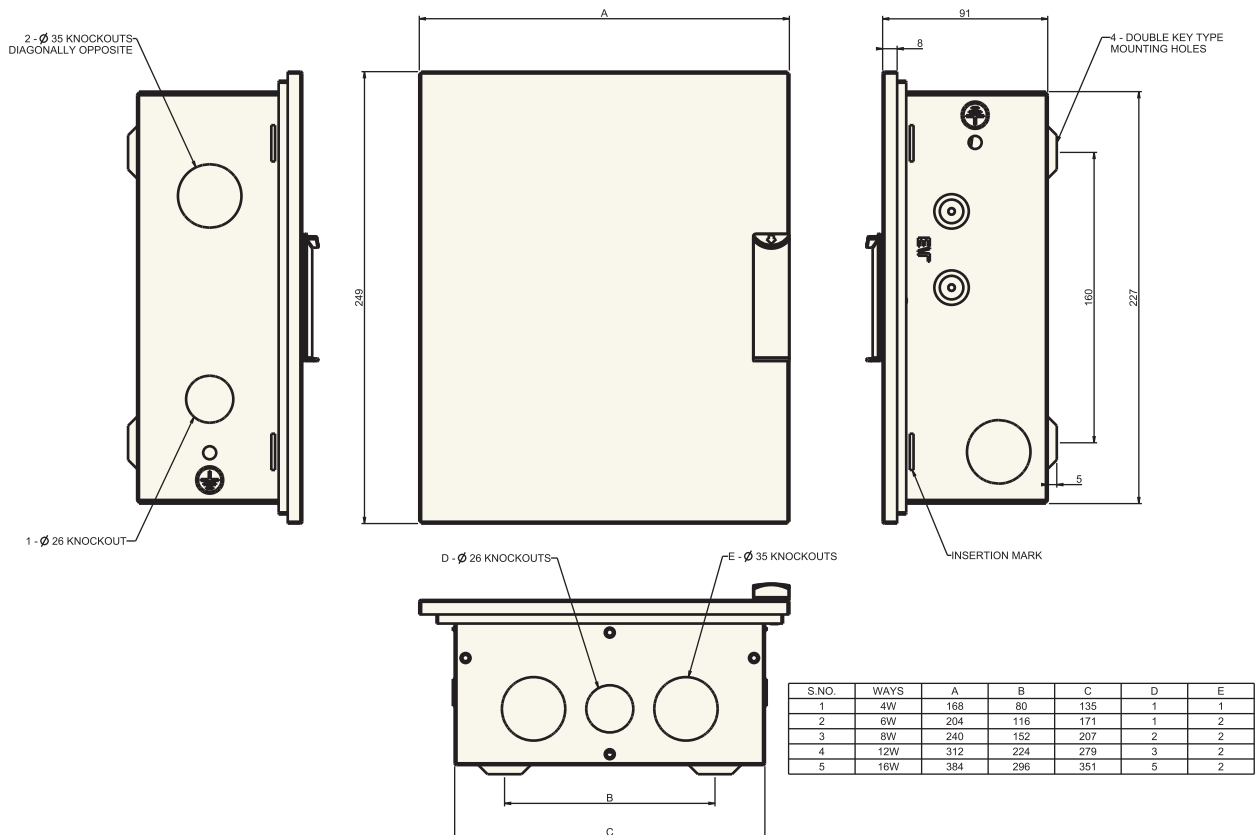

Dimensions

SPN DB Acrylic door

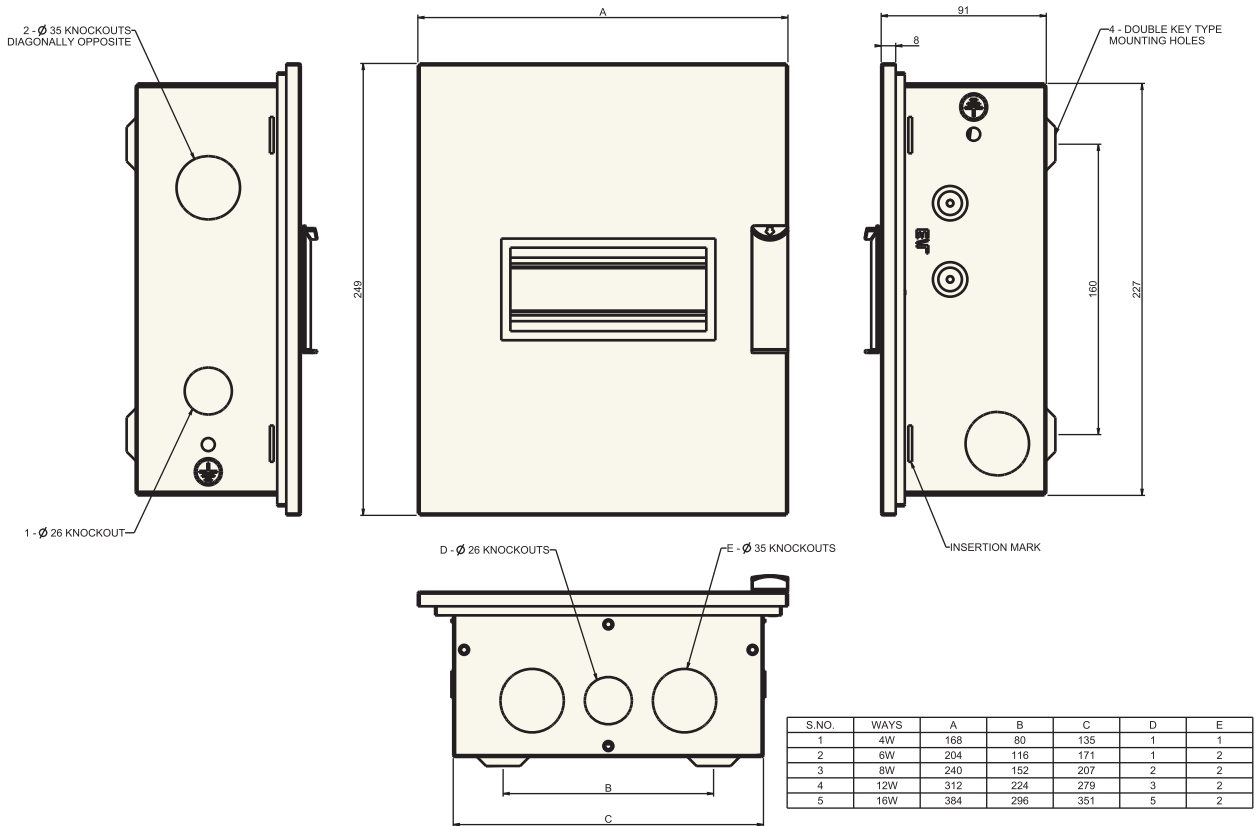

TPN DB Single door

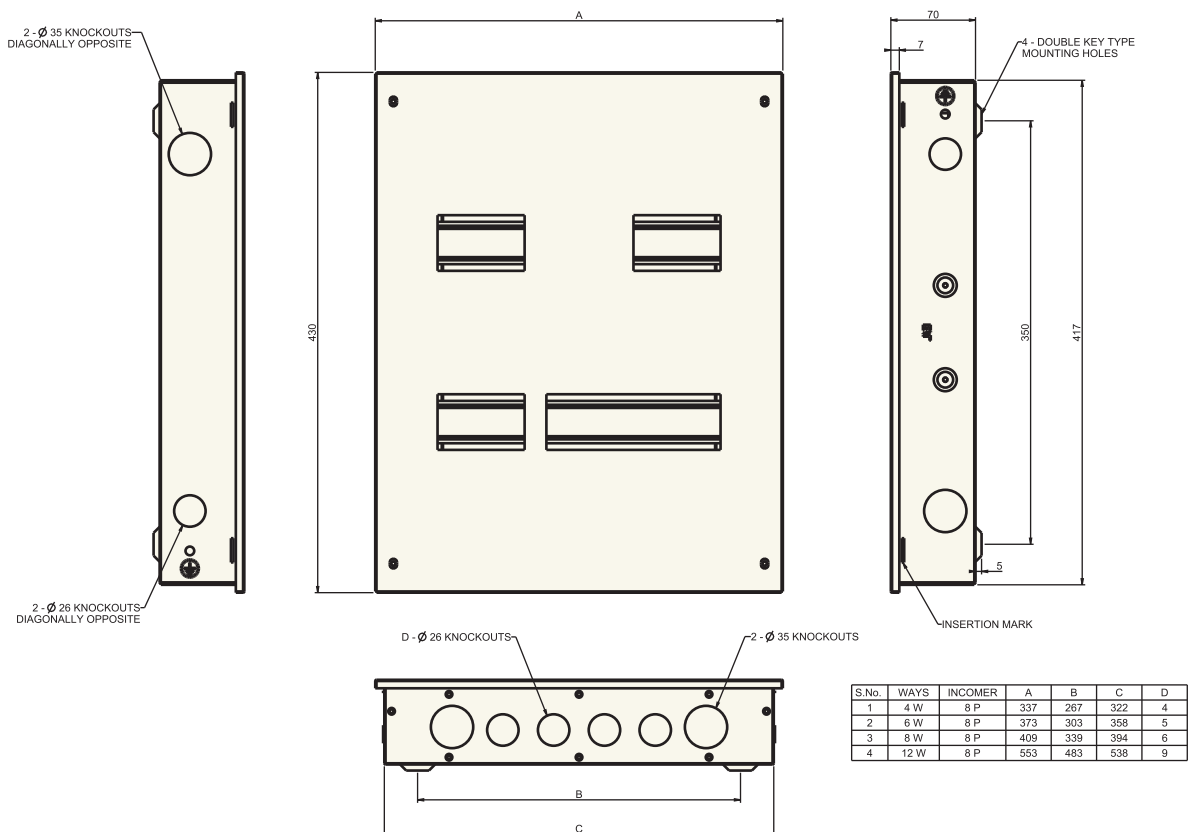

Dimensions

TPN DB Double door

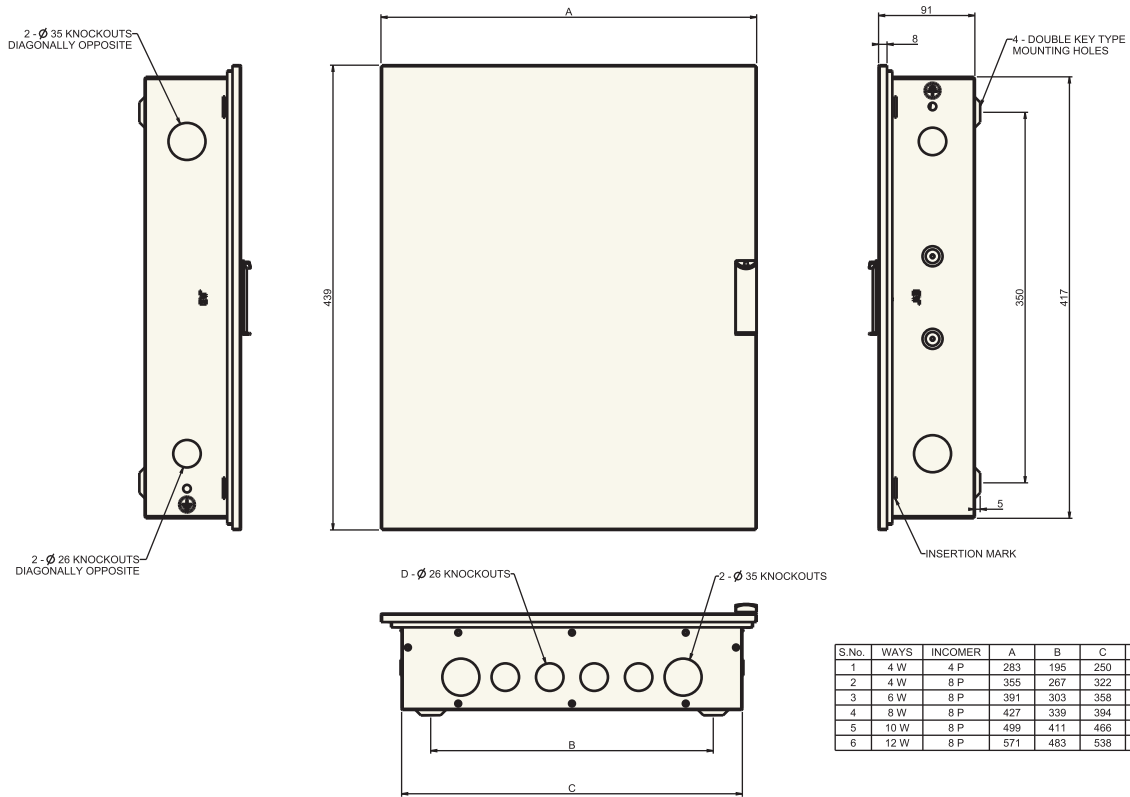

TPN DB Acrylic door

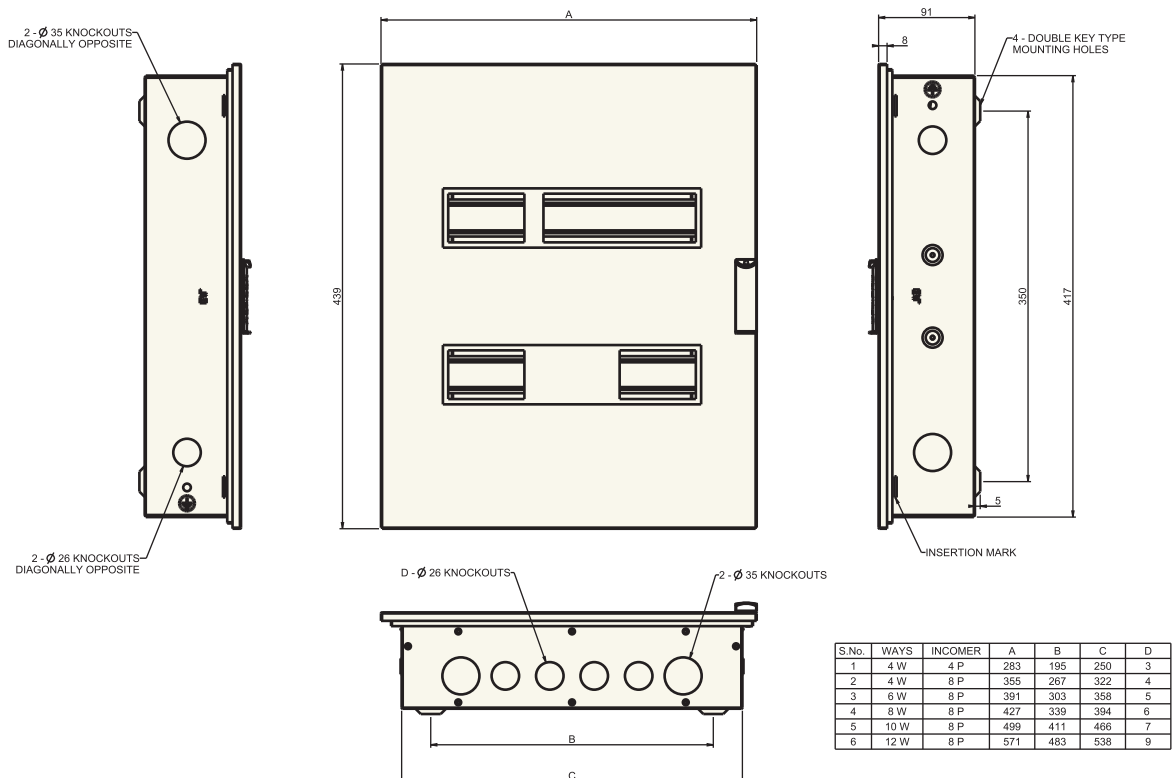

Dimensions

VTPN MCB DB Single door

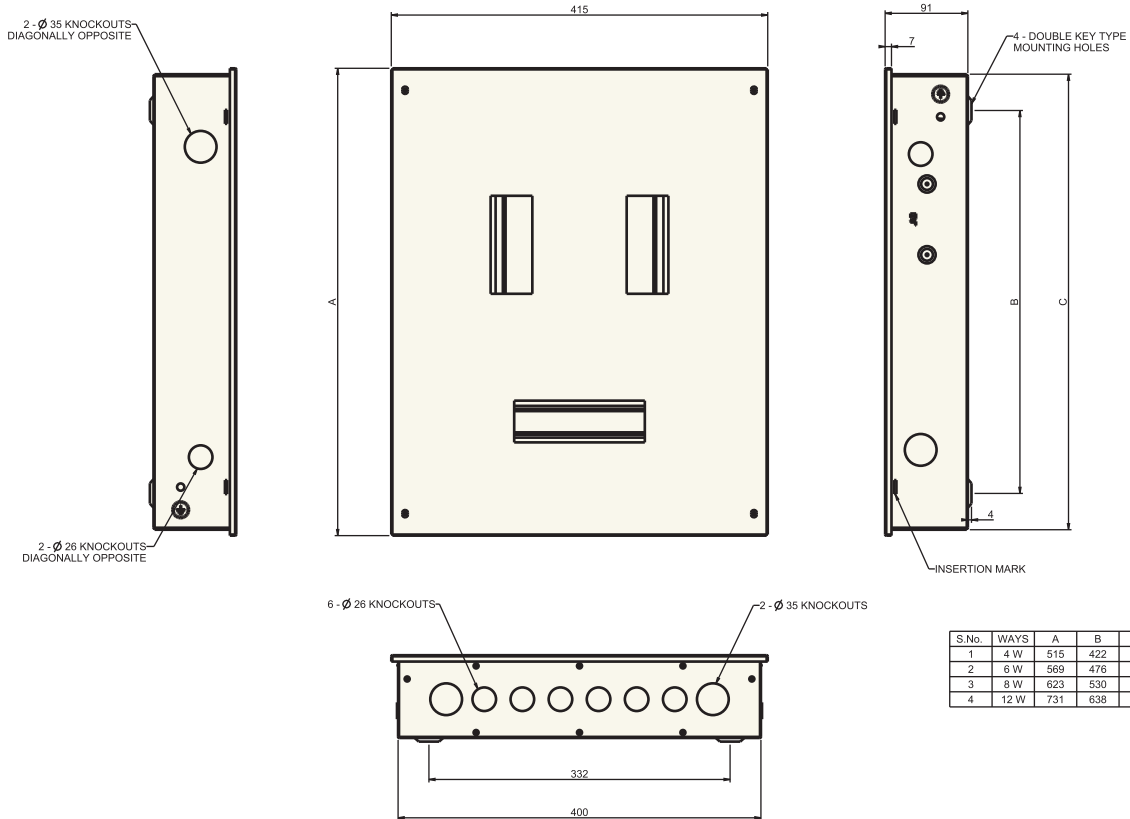

VTPN MCB DB Double door

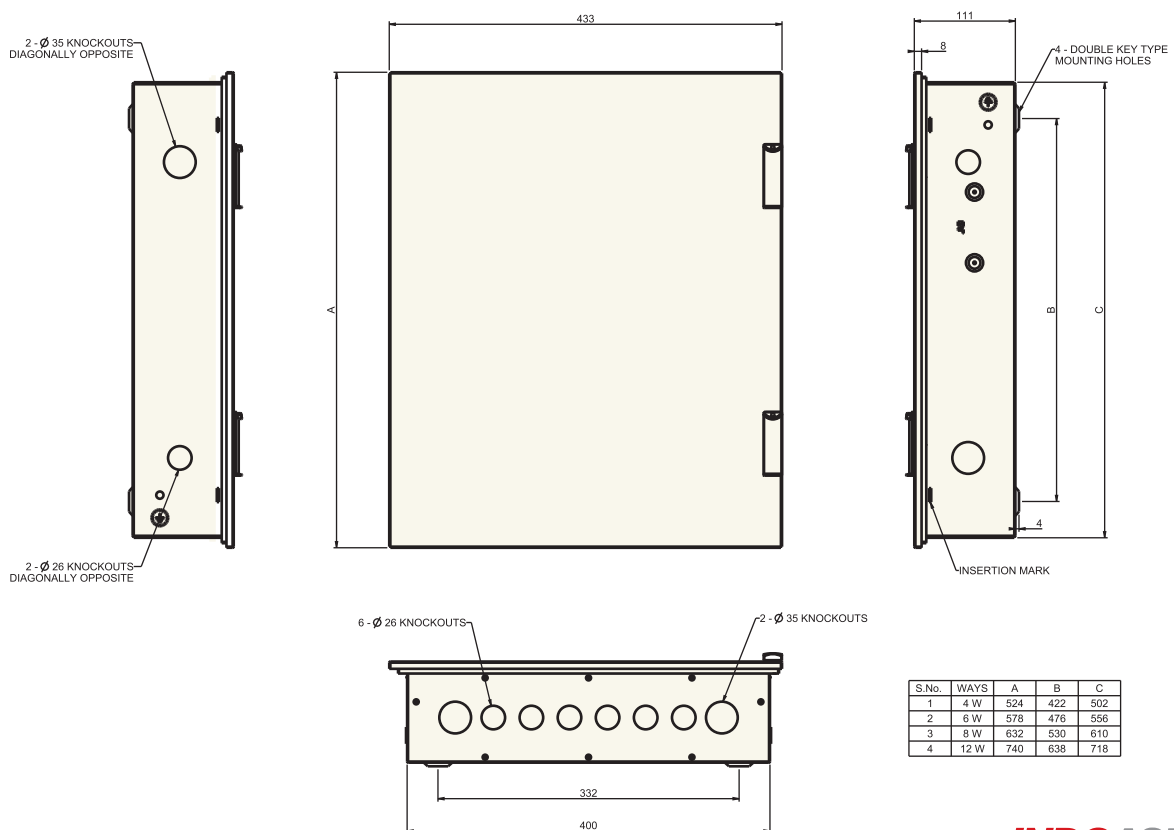

Dimensions

VTPN MCCB 125A DB-Double door

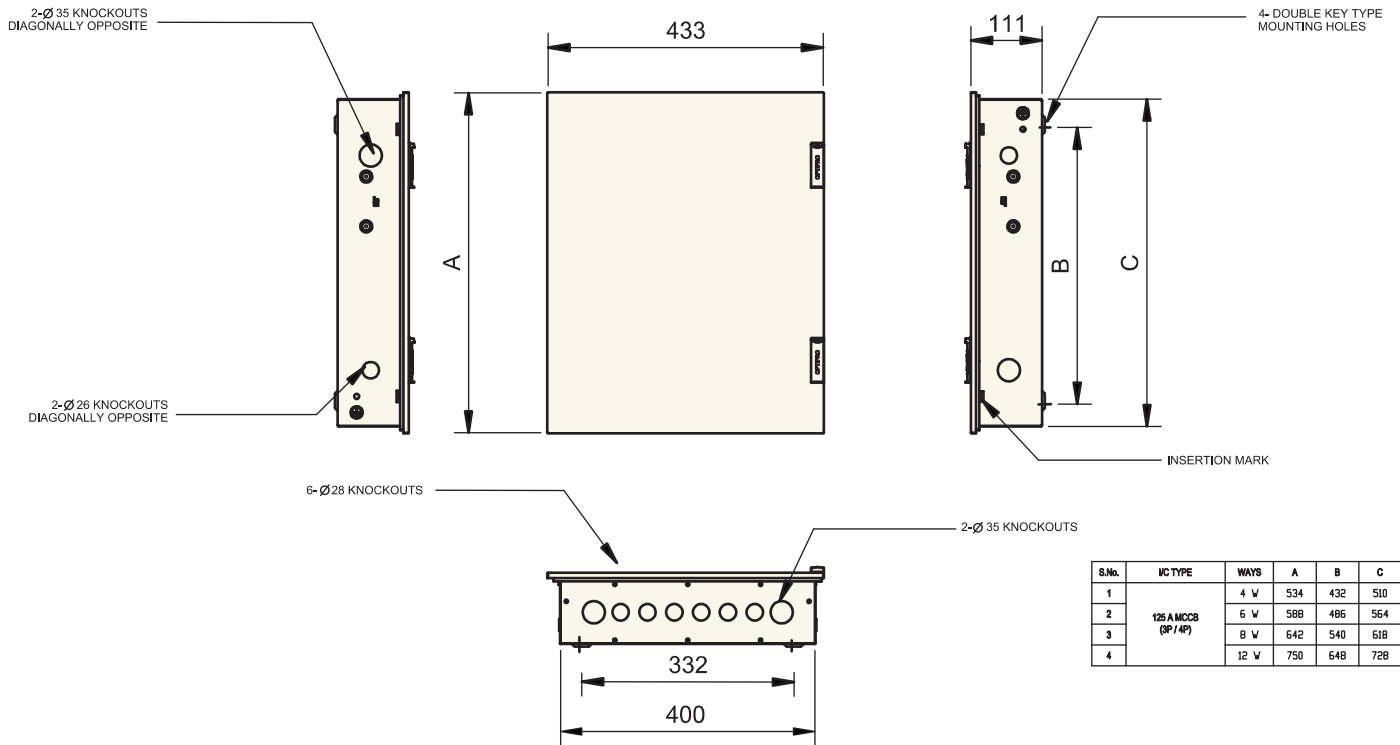

VTPN MCCB 250A DB-Double door

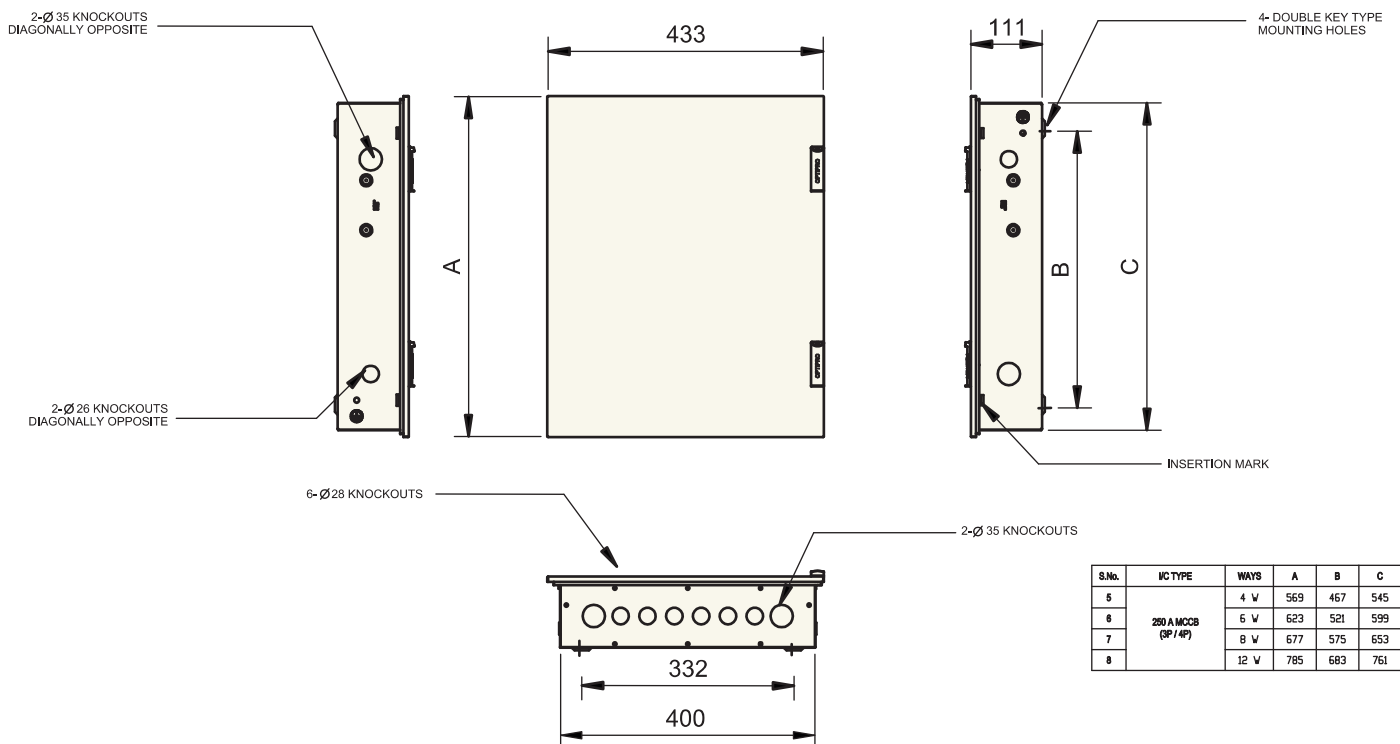

Dimensions

Flexi DB Double door

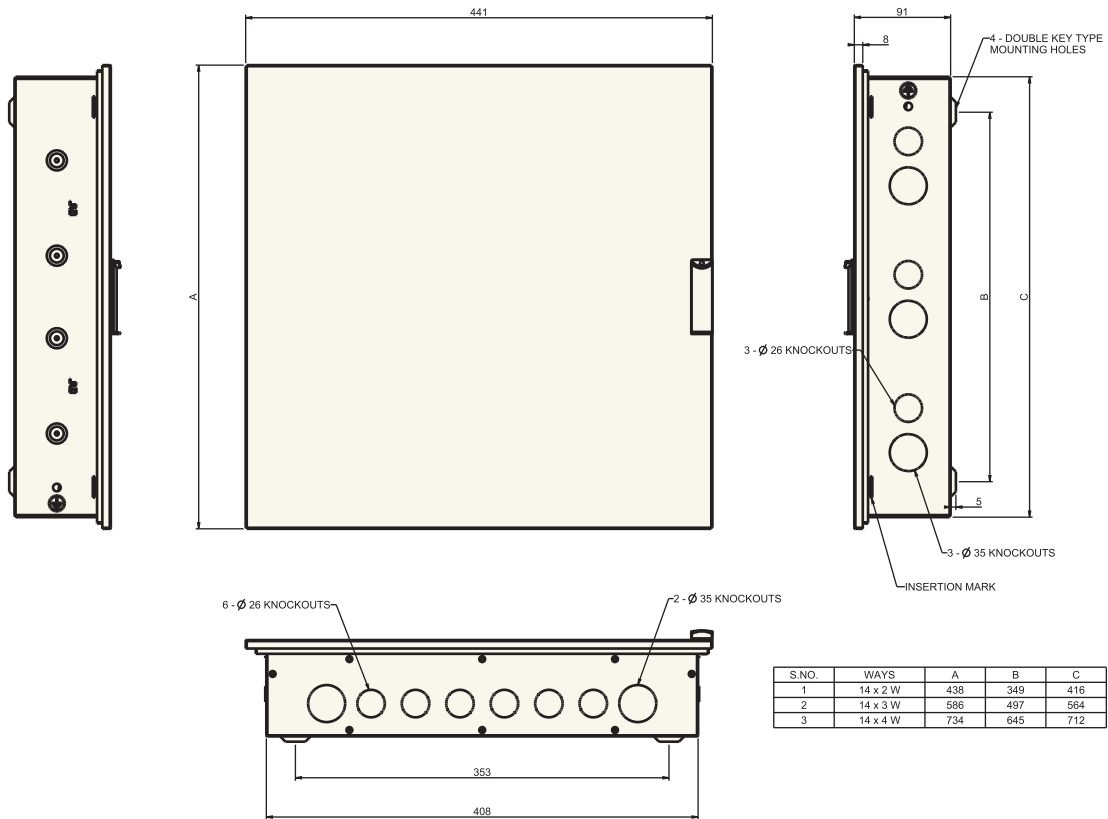

7 Segment DB Double door

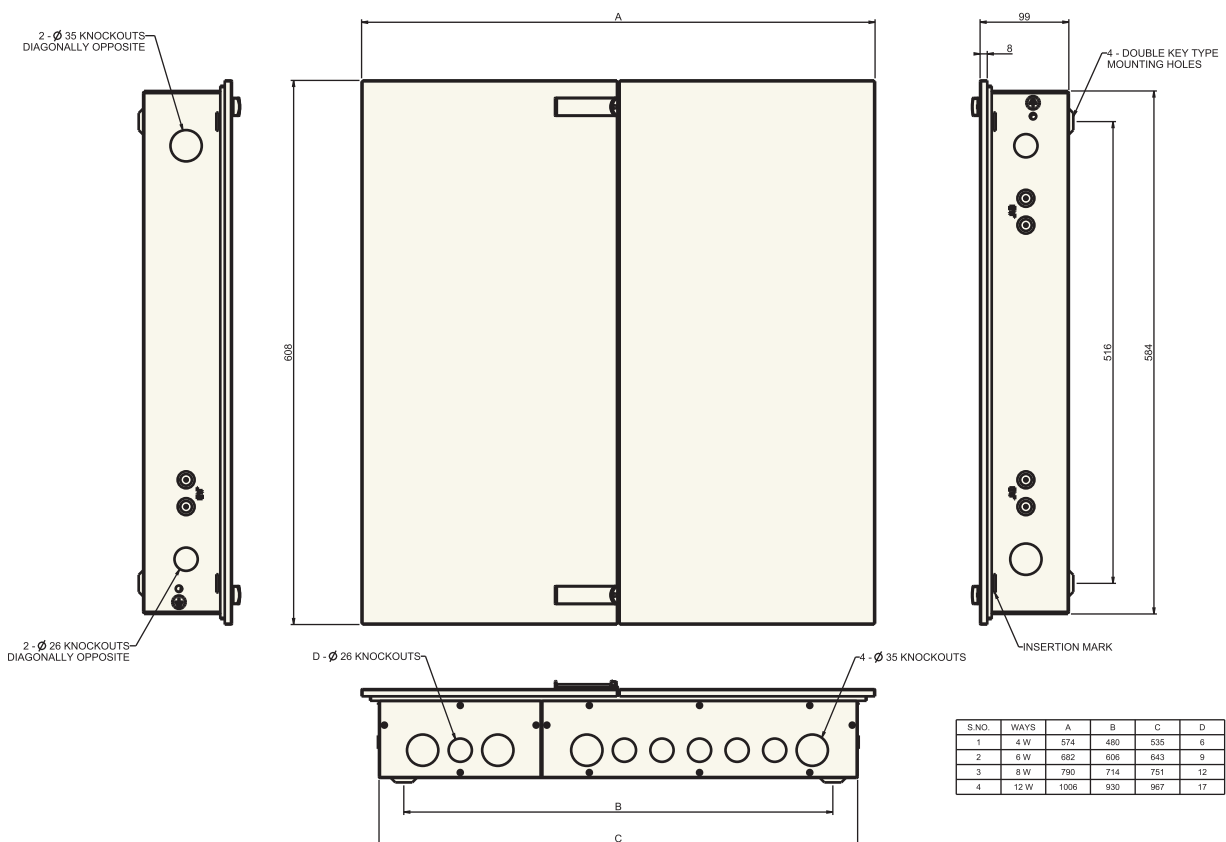

Dimensions

Phase selector DB 40A & 63A Double door

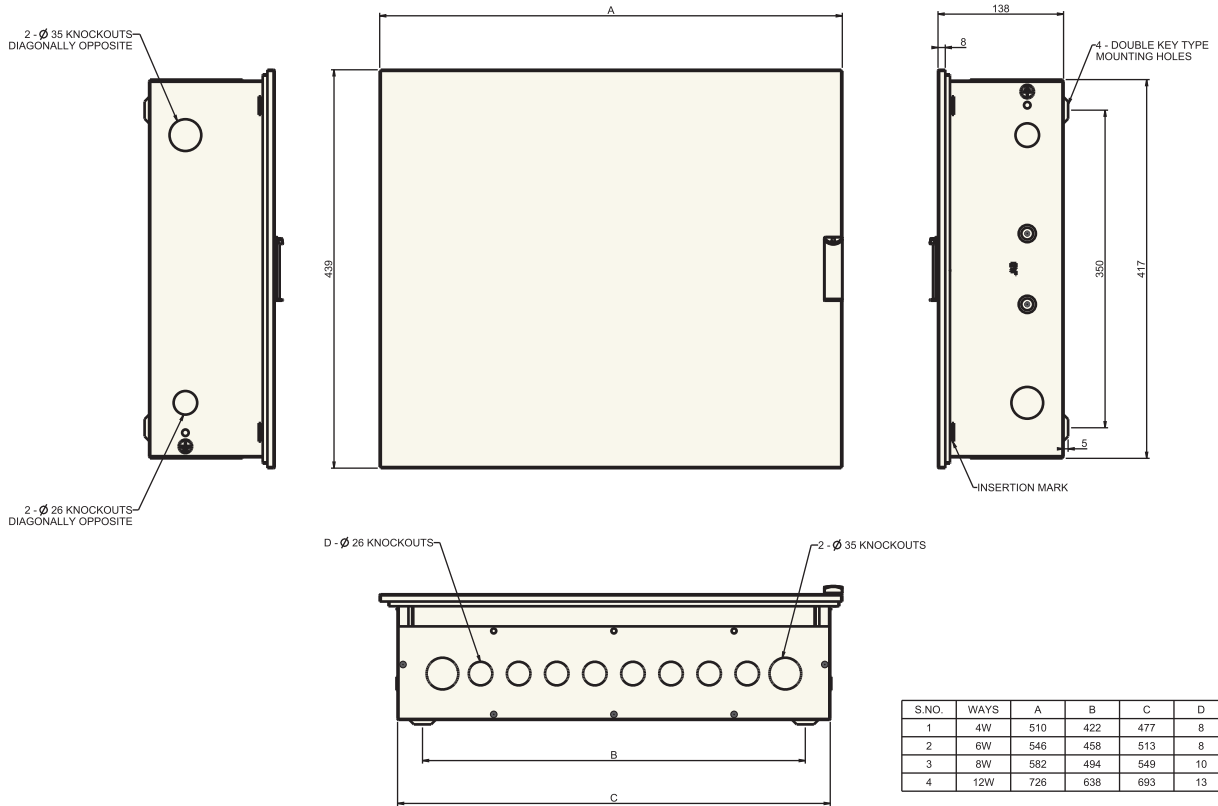

Metal Plug & Socket Box 20A SP & 20A DP

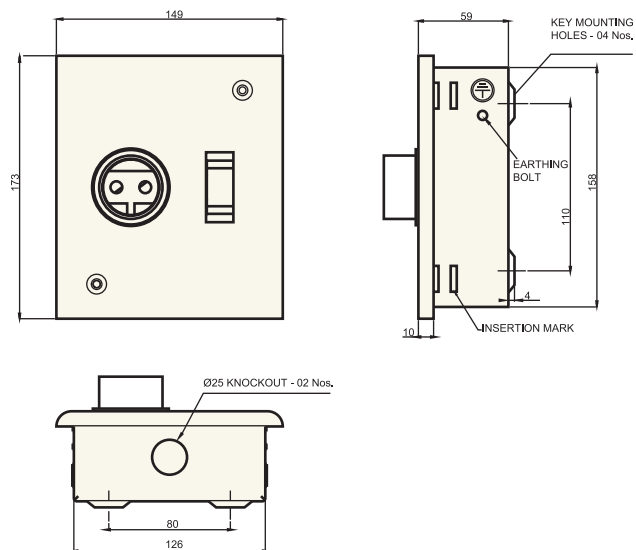

General Tolerance : ±2.0 mm

Dimensions

Metal Plug & Socket Box 20A & 32A TP

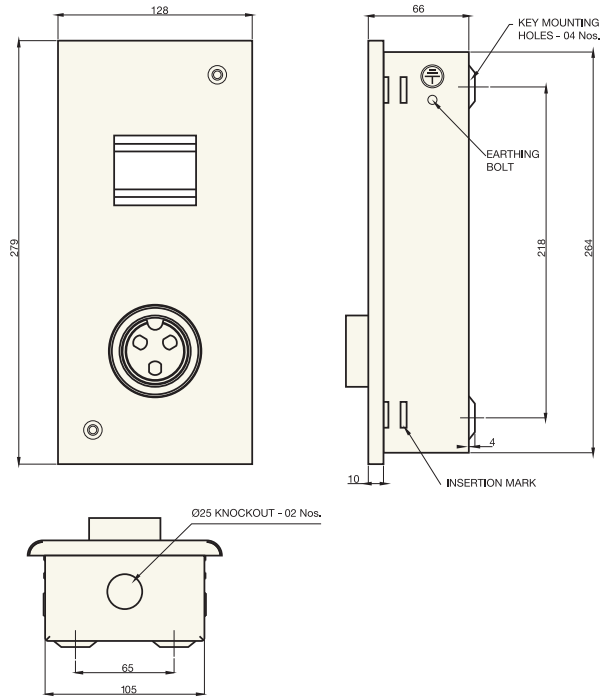

Plastic P&S 16A 3Pin

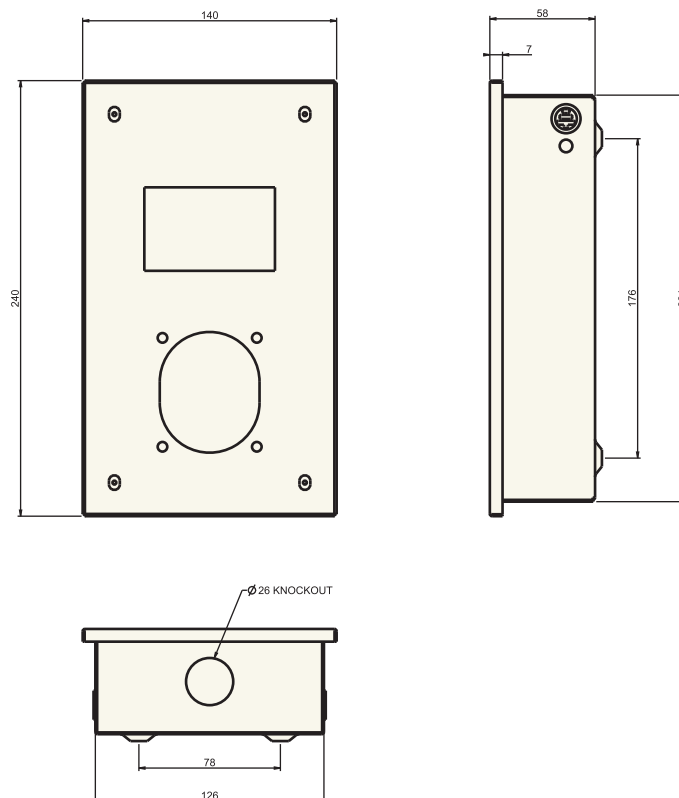

Dimensions

Plastic P&S 32A 3Pin / 5Pin

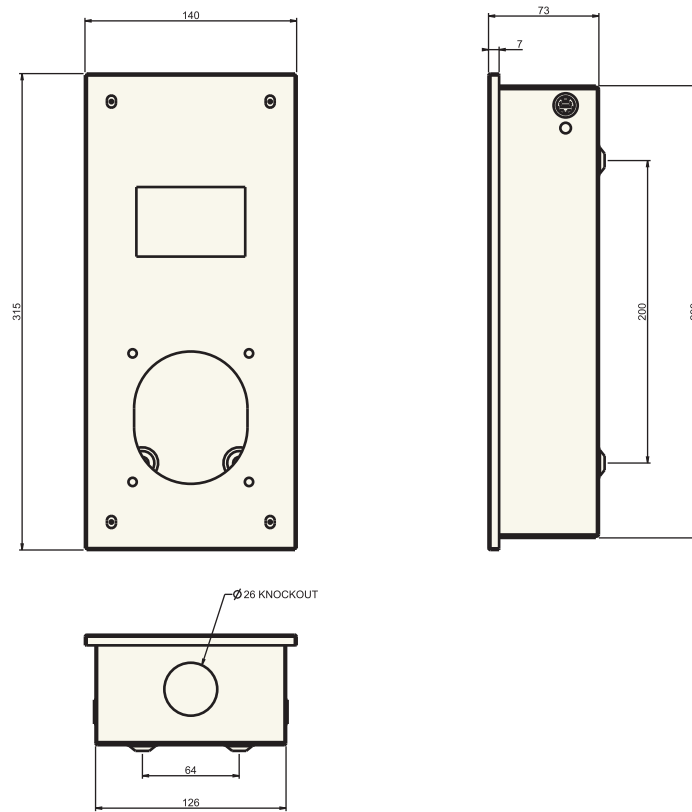

Plastic P&S 63A 5Pin

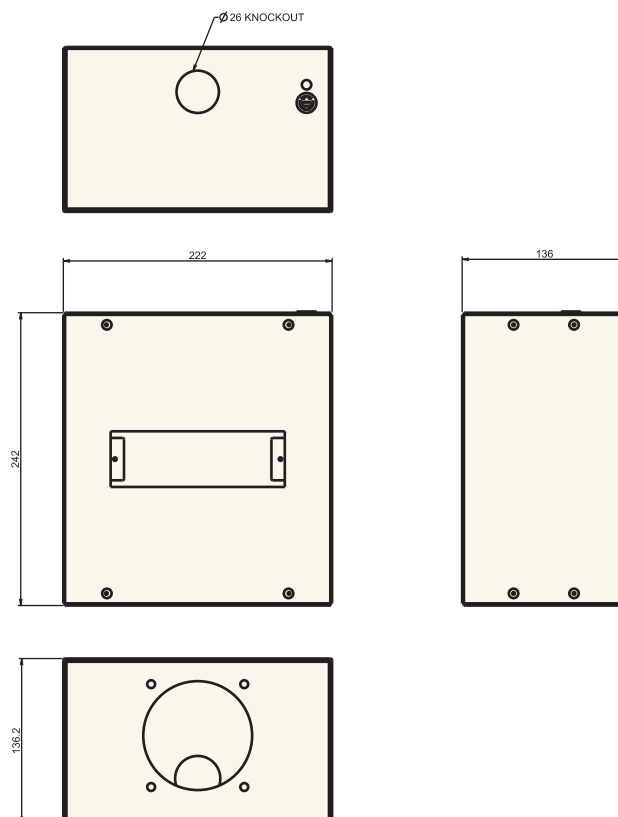

Dimensions

Metal Enclosure

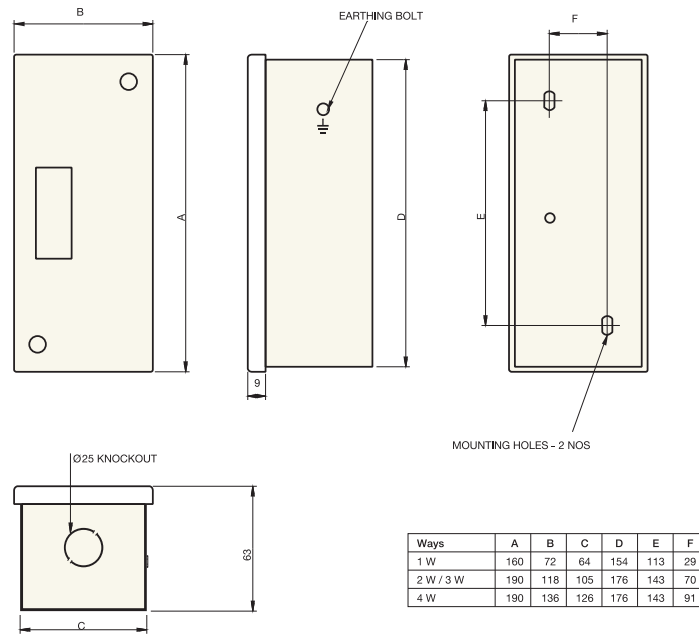

General Tolerance : ±2.0 mm

Plastic Enclosures

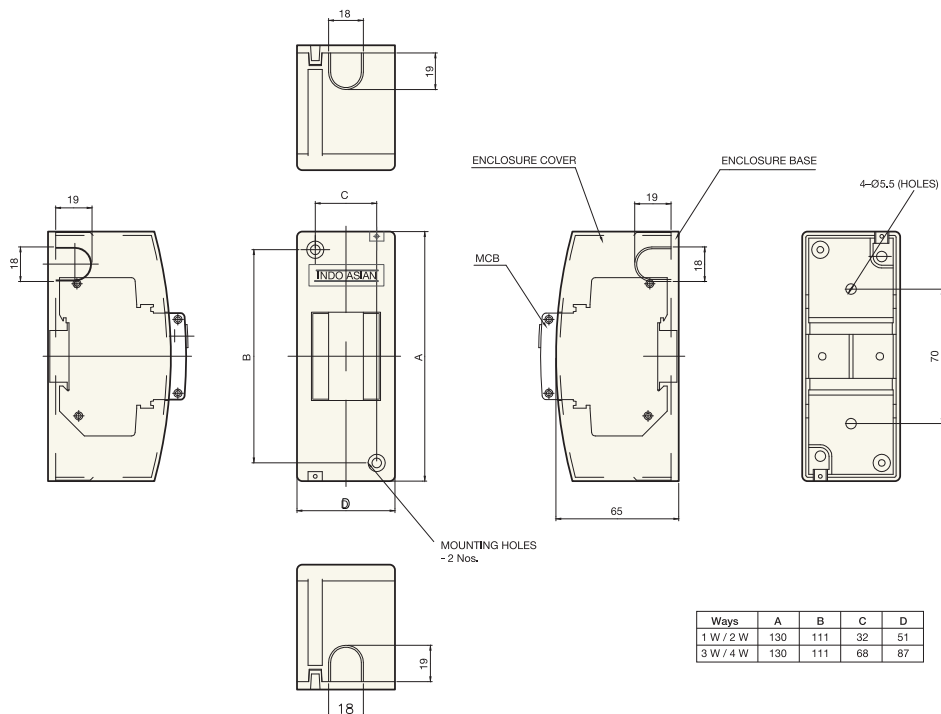

General Tolerance : ±2.0 mm

Dimensions

SPN TV/Tel. DB Double Door

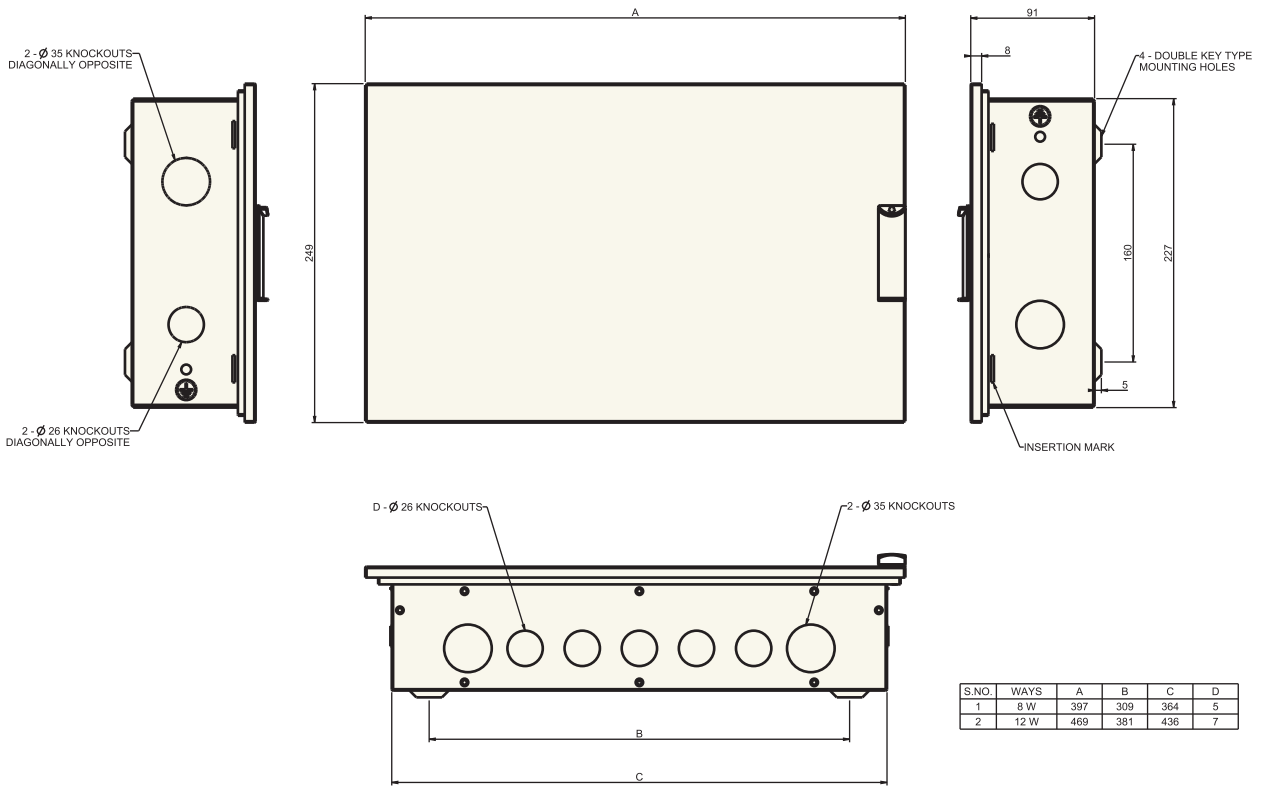

TPN TV/Tel. DB Double Door

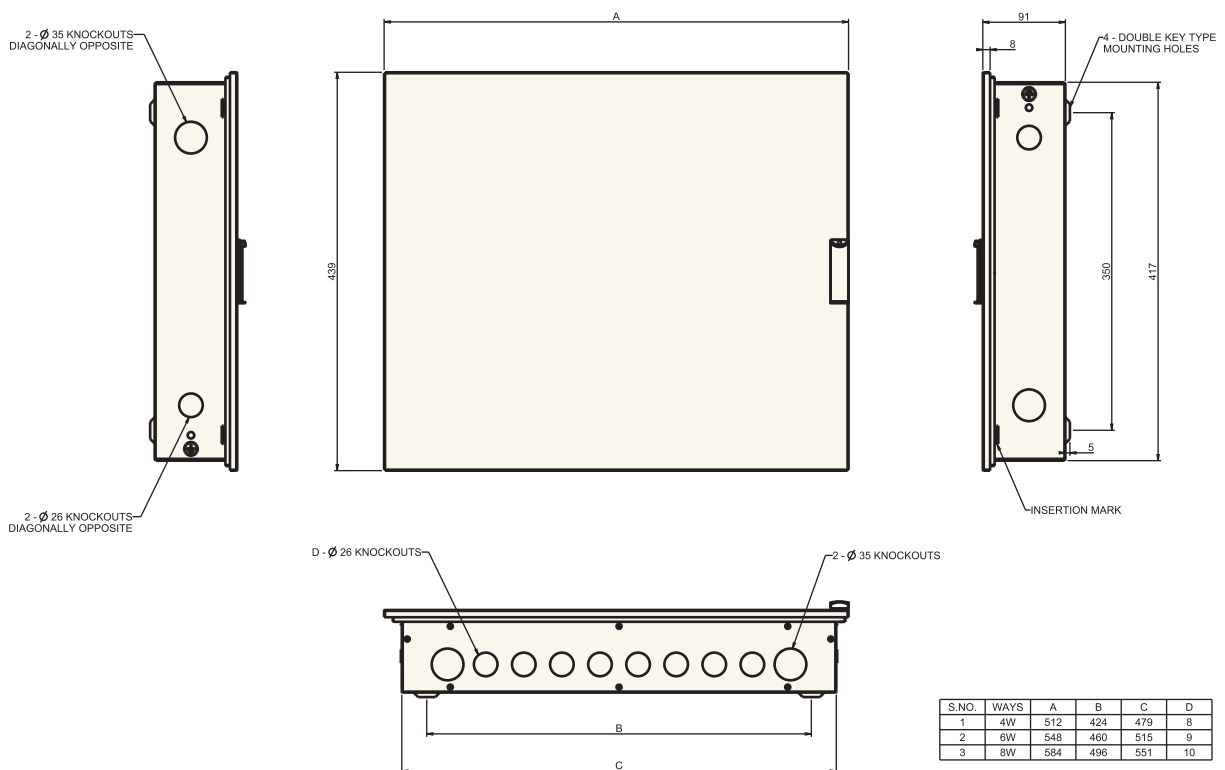

Dimensions

PPI Hor. DB Double Door

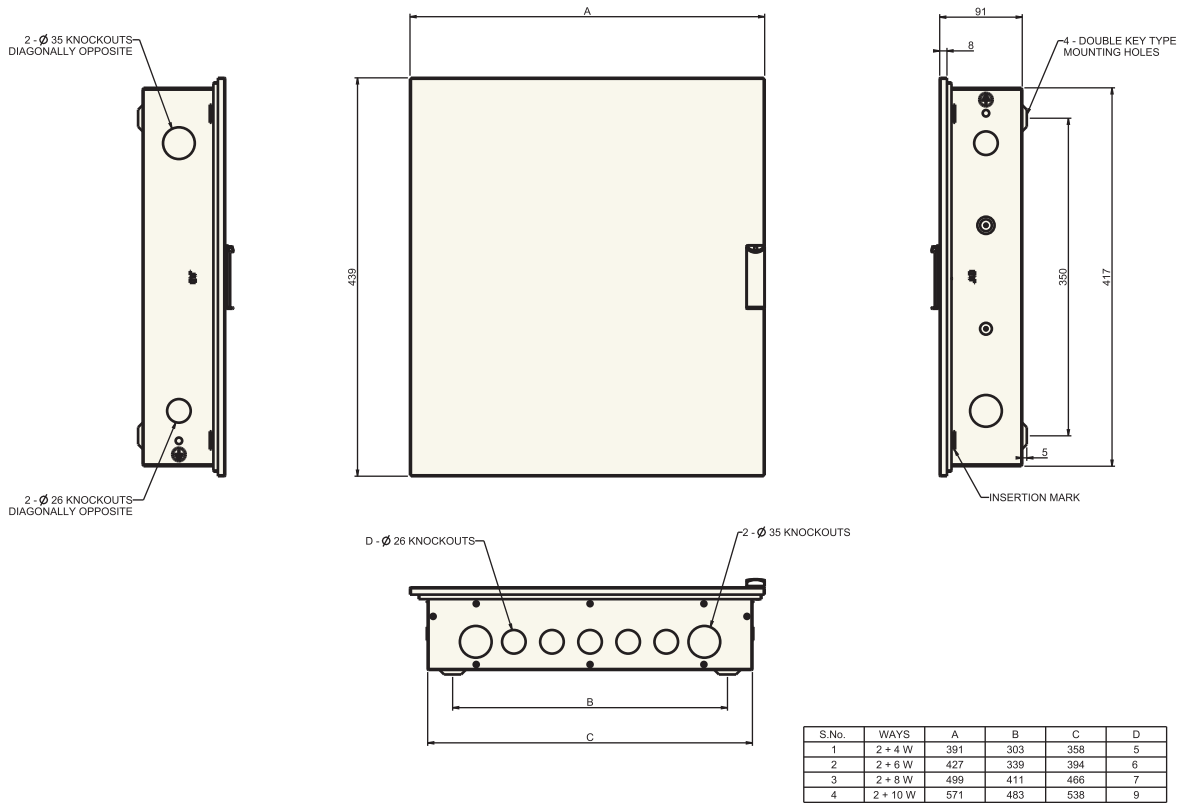

PPI Tier DB Double Door

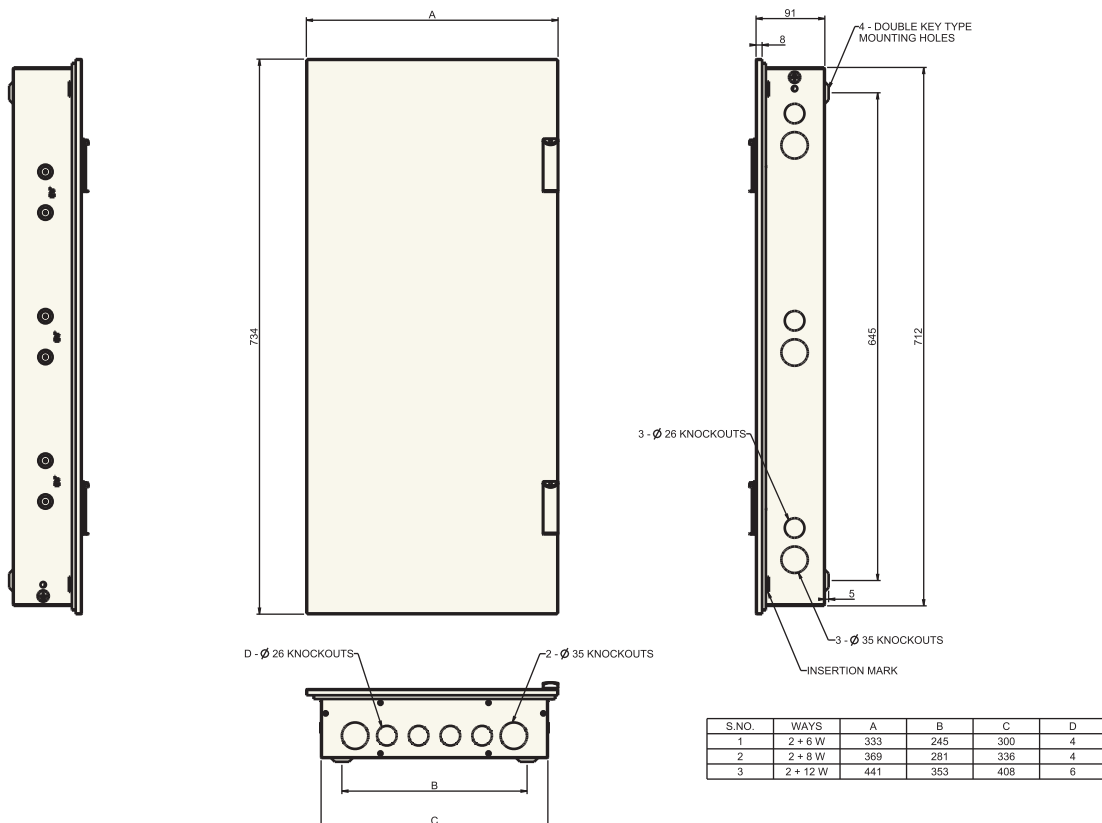



— optipro™ —

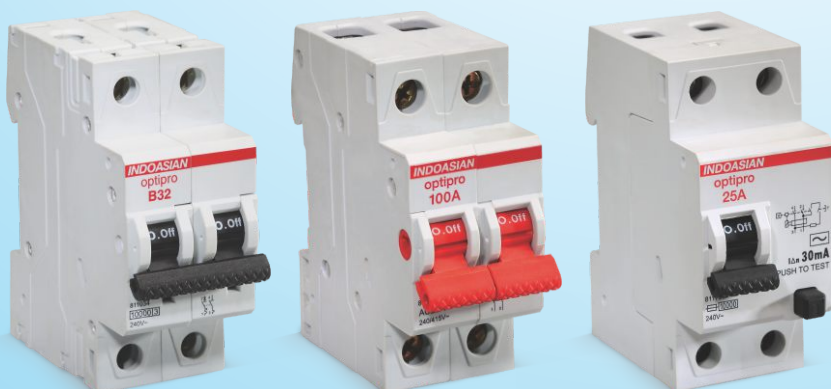

ALL THAT YOU NEED

Presenting Optipro. The complete range of protection devices for electrical systems, from the house of Indo Asian. Please approach the Indo Asian counter to discover more.

INDOASIAN TM
MAKES SENSE

SPN DB-Single door

- IP : 30 Protection
- Door Earthing
- Isolated Neutral Bar
- Mechanical Impact Strength Ik08
- Cement Spill Protector

| |  | | | |
|--|---|---------|-----------|-------|
| | Ways | Modules | Cat. Nos. | MRP ₹ |
| | 4 | 4 | 811800 | 756 |
| | 6 | 6 | 811801 | 930 |
| | 8 | 8 | 811802 | 966 |
| | 12 | 12 | 811803 | 1162 |
| | 16 | 16 | 811804 | 1466 |

SPN DB-Double door

- IP : 43 Protection
- Door Earthing
- Isolated Neutral Bar
- Mechanical Impact Strength Ik08
- Cement Spill Protector

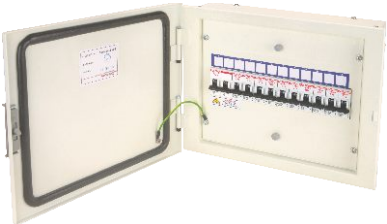
| |  | | | |
|--|---|---------|-----------|-------|
| | Ways | Modules | Cat. Nos. | MRP ₹ |
| | 4 | 4 | 811805 | 1104 |
| | 6 | 6 | 811806 | 1348 |
| | 8 | 8 | 811807 | 1442 |
| | 12 | 12 | 811808 | 1860 |
| | 16 | 16 | 811809 | 2302 |

SPN DB-Acrylic door

- IP : 43 Protection
- Cement Spill Protector
- Isolated Neutral Bar
- Door Earthing

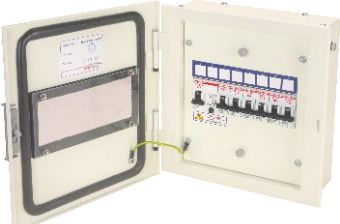
| |  | | | |
|--|---|---------|-----------|-------|
| | Ways | Modules | Cat. Nos. | MRP ₹ |
| | 4 | 4 | 811816 | 1270 |
| | 6 | 6 | 811817 | 1552 |
| | 8 | 8 | 811818 | 1658 |
| | 12 | 12 | 811819 | 2140 |
| | 16 | 16 | 811820 | 2648 |

TPN DB-Single door

- IP : 30 Protection
- Door Earthing
- Isolated Neutral Bar
- Mechanical Impact Strength Ik08
- Cement Spill Protector

|  | Ways | Modules | Cat. Nos. | MRP ₹ |
|---|---------------|---------|-----------|-------|
| | 4 Way compact | 4+12 | 811832 | 2000 |
| 4 Way | 8+12 | 811833 | 2210 | |
| 6 Way compact | 4+18 | 811834 | 2600 | |
| 6 Way | 8+18 | 811835 | 2884 | |
| 8 Way | 8+24 | 811836 | 3442 | |
| 12 Way | 8+36 | 811837 | 4768 | |

TPN DB-Double door

- IP : 43 Protection
- Door Earthing
- Isolated Neutral Bar
- Mechanical Impact Strength Ik08
- Cement Spill Protector

|  | Ways | Modules | Cat. Nos. | MRP ₹ |
|---|---------------|---------|-----------|-------|
| | 4 Way compact | 4+12 | 811840 | 2700 |
| 4 Way | 8+12 | 811841 | 3056 | |
| 6 Way compact | 4+18 | 811842 | 3500 | |
| 6 Way | 8+18 | 811843 | 3822 | |
| 8 Way | 8+24 | 811844 | 4706 | |
| 12 Way | 8+36 | 811845 | 6744 | |
| 16 Way | 8+48 | 811846 | 8140 | |

TPN DB-Acrylic door

- IP : 43 Protection
- Cement Spill Protector
- Isolated Neutral Bar
- Door Earthing

|  | Ways | Modules | Cat. Nos. | MRP ₹ |
|---|---------------|---------|-----------|-------|
| | 4 Way compact | 4+12 | 811848 | 3200 |
| 4 Way | 8+12 | 811849 | 3514 | |
| 6 Way compact | 4+18 | 811850 | 4100 | |
| 6 Way | 8+18 | 811851 | 4396 | |
| 8 Way | 8+24 | 811852 | 5410 | |
| 12 Way | 8+36 | 811853 | 7756 | |
| 16 Way | 8+48 | 811854 | 9360 | |

VTPN MCB DB-Single door

- IP : 30 Protection
- Door Earthing
- Isolated Neutral Bar
- Mechanical Impact Strength Ik08
- Insulated busbar assembly

|  | Ways | Modules | Cat. Nos. | MRP ₹ |
|---|--------|---------|-----------|-------|
| | 4 Way | 8+12 | 811864 | 6602 |
| | 6 Way | 8+18 | 811865 | 7906 |
| | 8 Way | 8+24 | 811866 | 8302 |
| | 12 Way | 8+36 | 811867 | 10438 |

VTPN MCB DB-Double door

- IP : 43 Protection
- Door Earthing
- Isolated Neutral Bar
- Mechanical Impact Strength Ik08
- Insulated busbar assembly

|  | Ways | Modules | Cat. Nos. | MRP ₹ |
|---|--------|---------|-----------|-------|
| | 4 Way | 8+12 | 811870 | 7768 |
| | 6 Way | 8+18 | 811871 | 9302 |
| | 8 Way | 8+24 | 811872 | 9768 |
| | 12 Way | 8+36 | 811873 | 12280 |

VTPN MCCB 125A DB-Double door

- IP : 43 Protection
- Door Earthing
- Isolated Neutral Bar
- Mechanical Impact Strength Ik08
- Insulated busbar assembly

|  | Ways | Modules | Cat. Nos. | MRP ₹ |
|---|--------|--------------|-----------|-------|
| | 4 Way | Optium F1+12 | 811888 | 8838 |
| | 6 Way | Optium F1+18 | 811889 | 10000 |
| | 8 Way | Optium F1+24 | 811890 | 10698 |
| | 12 Way | Optium F1+36 | 811891 | 14418 |

VTPN MCCB 250A DB-Double door

- IP : 43 Protection
- Door Earthing
- Isolated Neutral Bar
- Mechanical Impact Strength Ik08
- Insulated busbar assembly

| Ways | Modules | Cat. Nos. | MRP ₹ |
|--------|--------------|-----------|-------|
| 4 Way | Optium F2+12 | 811893 | 14884 |
| 6 Way | Optium F2+18 | 811894 | 15582 |
| 8 Way | Optium F2+24 | 811895 | 18256 |
| 12 Way | Optium F2+36 | 811896 | 19534 |

Flexi DB-Double door

- IP : 43 Protection
- Door Earthing
- Isolated Neutral Bar
- Mechanical Impact Strength Ik08
- Cement Spill Protector

| Ways | Modules | Cat. Nos. | MRP ₹ |
|------------|---------|-----------|-------|
| 14 X 2 Row | 28 | 811912 | 4186 |
| 14 X 3 Row | 42 | 811913 | 4976 |
| 14 X 4 Row | 56 | 811915 | 5534 |

7 Segment DB-Double door

- IP : 43 Protection
- Door Earthing
- Isolated Neutral Bar
- Mechanical Impact Strength Ik08
- Compartmentalized solution

| Ways | Modules | Cat. Nos. | MRP ₹ |
|--------|---------|-----------|-------|
| 4 Way | 8+12+12 | 811925 | 7162 |
| 6 Way | 8+12+18 | 811926 | 8094 |
| 8 Way | 8+12+24 | 811927 | 9302 |
| 12 Way | 8+12+36 | 811928 | 11628 |

Phase selector DB 40A Double door

- IP : 43 Protection
- Door Earthing
- 40 A prefitted selector switch
- Mechanical Impact Strength Ik08
- Isolated Neutral Bar

| Ways | Modules | Cat. Nos. | MRP ₹ |
|--------|---------|-----------|-------|
| 4 Way | 4+12 | 811940 | 8472 |
| 6 Way | 4+18 | 811941 | 8840 |
| 8 Way | 8+24 | 811942 | 9598 |
| 12 Way | 8+36 | 811943 | 10808 |

Phase selector DB 63A Double door

- IP : 43 Protection
- Door Earthing
- 63 A prefitted selector switch
- Mechanical Impact Strength Ik08
- Isolated Neutral Bar

| Ways | Modules | Cat. Nos. | MRP ₹ |
|--------|---------|-----------|-------|
| 4 Way | 4+12 | 811950 | 9966 |
| 6 Way | 4+18 | 811951 | 10400 |
| 8 Way | 8+24 | 811952 | 11292 |
| 12 Way | 8+36 | 811953 | 12716 |

Metal clad P&S

- IP : 30 Protection
- Without MCBs
- Mechanical Impact Strength Ik08

| Ways | Modules | Cat. Nos. | MRP ₹ |
|----------|---------|-----------|-------|
| 20A 2P+E | 1 Mod | 811955 | 838 |
| 20A 2P+E | 2 Mod | 811956 | 838 |
| 20A 3P+E | 3 Mod | 811957 | 1860 |
| 32A 3P+E | 3 Mod | 811958 | 2652 |

Plastic P&S

- IP : 30 Protection
- Without MCBs

| Ways | Modules | Cat. Nos. | MRP ₹ |
|------------|---------|-----------|-------|
| 16A 2P+E | 2 Mod | 811959 | 2216 |
| 32A 2P+E | 2 Mod | 811960 | 3294 |
| 32A 3P+N+E | 4 Mod | 811961 | 3628 |
| 63A 3P+N+E | 4 Mod | 811962 | 10024 |

Enclosures

| Ways | Modules | Cat. Nos. | MRP ₹ |
|-----------------|---------|-----------|-------|
| 1/2 Mod plastic | 2 | 811977 | 126 |
| 3/4 Mod plastic | 4 | 811978 | 198 |
| 1 Mod metal | 1 | 811979 | 280 |
| 2 Mod metal | 2 | 811980 | 280 |
| 3 Mod metal | 3 | 811981 | 372 |
| 4 Mod metal | 4 | 811982 | 372 |

TV/TEL DB

- IP : 43 Protection
- Isolated Neutral Bar & Shrouded Bus Bar
- Mechanical Impact Strength Ik08
- Factory fitted KRONE type TV & TEL socket
- Door Earthing

| Ways | Modules | Cat. Nos. | MRP ₹ |
|------------|---------|-----------|-------|
| 8 Way SPN | 8 | 811963 | 3500 |
| 12 Way SPN | 12 | 811964 | 3950 |
| 4 Way TPN | 8+12 | 811967 | 5600 |
| 6 Way TPN | 8+18 | 811983 | 5950 |
| 8 Way TPN | 8+24 | 811968 | 6600 |

PPI DB

- IP : 43 Protection
- Door Earthing
- Isolated Neutral Bar for individual phase
- Mechanical Impact Strength Ik08
- Cement Spill Protector

| Ways | Modules | Cat. Nos. | MRP ₹ |
|---------------|---------|-----------|-------|
| Hori 4+2 Way | 8+6+12 | 811971 | 5862 |
| Hori 6+2 Way | 8+6+18 | 811972 | 7188 |
| Hori 8+2 Way | 8+6+24 | 811973 | 8514 |
| Tier 6+2 Way | 8+6+18 | 811974 | 6600 |
| Tier 8+2 Way | 8+6+24 | 811975 | 8162 |
| Tier 12+2 Way | 8+6+36 | 811976 | 9590 |

CORPORATE OFFICE:

B-24, Phase - II, Noida - 201305, U.P., India Ph.: +91-120-3853000 Fax: +91-120-3853002
E-mail: sales@indoasian.com, international@indoasian.com Website: www.indoasian.com

CUSTOMER CARE SUPPORT EXECUTIVE:

B-24, Phase - II, Noida - 201305, U.P., India Ph.: +91-120-3042222 E-mail: feedback@indoasian.com

NORTH

CHANDIGARH

S.C.O.-11, 2nd Floor,
Madhya Marg, Sector-26,
Chandigarh-160002
Ph.: 0172-3934651-64
Telefax: 0172-3934656
E-Mail: in-chandigarh-office@indoasian.com

DELHI

721-722, 7th Floor,
DLF Tower B,
Jasola District Centre,
New Delhi-110044
Ph.: 011-30821773-74
E-Mail: in-delhi-office@indoasian.com

JAIPUR

433, Ganpati Plaza,
M. I. Road,
Jaipur-302001
Ph.: 0141-4113528
E-Mail: in-jaipur-office@indoasian.com

LUCKNOW

301, Chintel House, Station Road,
Lucknow-226001
Ph.: 0522-4013210
TeleFax: 0522-4013210
E-Mail: in-lucknow-office@indoasian.com

SOUTH

BANGALORE

402, 4th Floor, Blue Cross Chambers,
Infantry Road Cross,
Bangalore-560001
Ph.: 080-25585043, 25591677
Fax: 080-25591546
E-Mail: in-bangalore-office@indoasian.com

COCHIN

Door No. 65/1317,
Syda Building, 2nd Floor,
Kaloor-Kadavanthra Road, Kaloor,
Ernakulam District, Kochi-682017 (Kerala)
Ph.: 0484-4055581-88
E-Mail: in-cochin-office@indoasian.com

COIMBATORE

D. No. 83,
Dr. Nanjappa Road,
Coimbatore-641018
Ph.: 0422-2302715
Fax: 0422-2302715
E-Mail: in-coimbatore-office@indoasian.com

CHENNAI

No. 5, Mahalingapuram Main Road,
Nungambakkam,
Chennai-600034
Ph.: 044-28172096, 28170527
E-Mail: in-chennai-office@indoasian.com

HYDERABAD

312, 3rd Floor, Amrutha Estates,
Himayath Nagar,
Hyderabad-500029
Ph.: 040-66742425-29
E-Mail: in-secunderabad-office@indoasian.com

WEST

AHMEDABAD

203-204, Shreedhar Avenue,
11, Sardar Patel Colony,
Near Sardar Patel Statue,
Naranpura, Ahmedabad-380014
Ph.: 079-30002092-94
E-Mail: in-ahmedabad-office@indoasian.com

INDORE

202, KK Bafna Arcade,
Janjeerwala Square,
Racecourse Road,
Indore-401408
Ph.: 09713055522
E-Mail: in-indore-office@indoasian.com

MUMBAI

401 & 408, K.P. Arrum,
Marol Morshi Road, Andheri East,
Mumbai-400059
Ph.: 022-61035800
E-Mail: in-mumbai-office@indoasian.com

PUNE

Rajadwar Building, 4th Floor,
1307, Shivaji Nagar, Off. J. M. Road,
Pune-411005
Ph.: 020-60500440, 60502255
Fax: 020-25520659
E-Mail: in-pune-office@indoasian.com

EAST

KOLKATA

Raikva Building, Room No. 8, 2nd Floor,
3A Ram Mohan Garden Lane,
Beliaghata E.M.Bypass, Kolkata-700010
Ph.: 033-66041503-04
E-Mail: in-kolkata-office@indoasian.com