

WE THINK
YOU LIVE
BETTER BETTER

ELVIRA

A SENSIBLE SWITCH

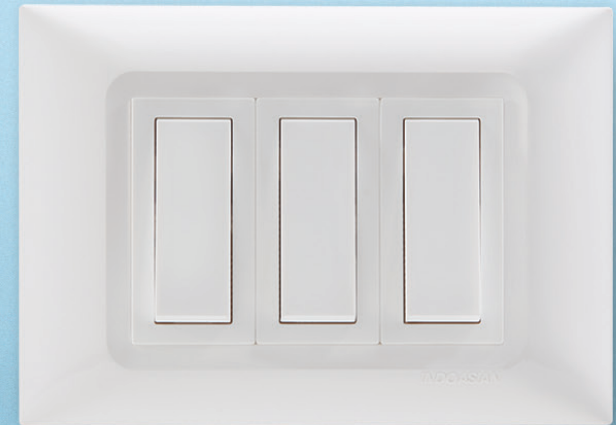

DISCOVER
THE THINKING
THAT GOES INTO
MAKING LIFE
BETTER.

Before we started creating a top quality switch, we put you at the centre of our thinking. And while this seemed easy, the thought that



went into creating a superior-quality, longer lasting, greater value-for-money product wasn't an easy task. We focused on attributing it with better features and better functionality, but more importantly, making it more practical. And when it all came together, it just made the best sense.

Elvira: A Sensible Switch.

Because at IndoAsian, *everything* **Makes Sense.**

FEATURES

There are so many reasons why Elvira is the right choice for you. We've listed 12 sound and sensible ways in which Elvira can help you live better. We're sure you will be able to find 12 more.



DESIGNED FOR YOU

Neutral, white colour

Everyone prefers pure and bright white, not because it's simply a better choice but because it's more elegant. It gives you more options and the flexibility to change wall colours.

Built to last

Elvira is also designed to last longer. From curved, screw-free exteriors, to honeycomb base plates, there are even flexible clips for greater stability and strength.



COMPLETELY
COMPATIBLE



Simple 3 pin design

Loose connections are now a thing of the past. The simplified three-pin design has flat and round terminals which means compatibility with all 2 and 3 pin plugs.



SERIOUSLY SAFE

Shrouded terminals

This minimises exposure from accidental contact with live screws and terminals during installation for the electrician.

Base shutters

We've moved the shutter from the top round hole to the base, thereby needing contact from both plug pins and giving complete protection to the curious child.



TOTALLY TRUSTWORTHY

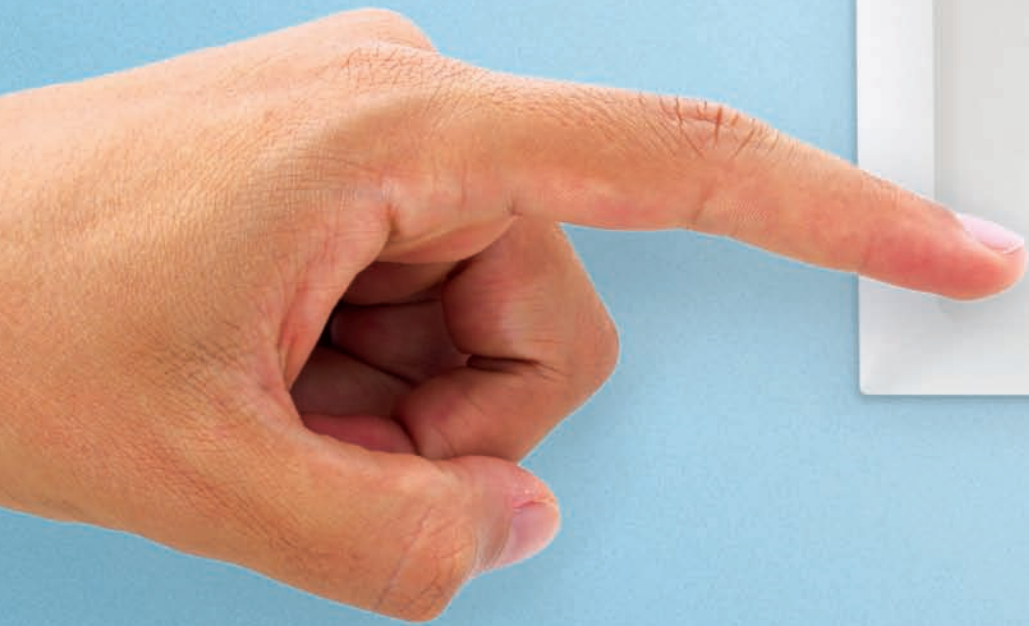

Quality standards

There's a reason why IndoAsian is preferred; the ISI mark is a universally-recognised quality standard. Rigorous testing exceeding 1 lakh On/Off operations means that our switches will last you more than a decade.

HIGHLY DURABLE



High-grade Polycarbonate switches

Our Polycarbonate switches are FR grade with sun protection. They are heat-resistant, flame-retardant and even UV-stabilised. The high grade of Polycarbonate that we use adds to the structural stability.

EXTRA
EFFICIENT



Detailing for installation

Behind every switch we've indicated which side is Top, which means your electrician will always install the products correctly. No mixing up of directions, no time wasted.

EFFECTIVELY POWERED



Unique indicator switches

Our indicator switches are powered with LED, which implies longer life and less energy consumption.

The unique indicator design delivers brightness greater than neon indicators, making it even more efficient.

TRULY PERMANENT

Laser-etched switches

Laser technology replaces printing and painting for easy identification of product ratings and descriptions. All our switches are permanently etched in high-contrast, clear figures and letters that are guaranteed to last long.



The Elvira wiring system consists of switches, sockets and indicators that are functional, yet packed with features. This high-quality range extends to more products that simply improve your life. This includes separate dimmers and fan regulators that aren't interchangeable, call bells and push bells with indicators, skirting lights, and 25A sockets and motor starters.



6A/16A 1way Switch



6A/16A 2way Switch



6A/16A/25A 1way Switch with indicator



6A 3 Pin Universal Socket



10A Euro US Socket



Multistandard Socket 6/10/13A-250v



Fan Step Regulator 100W -1M



Fan Step Regulator 100W - 2M



Light Dimmer 400W



20A/32A DP Switch



6A Bell Push with indicator - 1M



6A Bell Push with indicator - 2M



Buzzer 230V



Cable Outlet



6/16A 3 Pin Socket



25A 3 Pin Socket



TV Socket



Tel Socket - RJ11



Computer Socket
RJ45 Cat 6



Bell Call Indicator

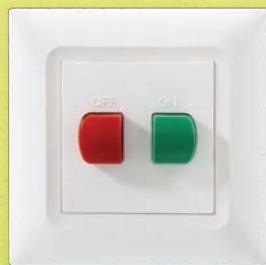

25A Motor Starter

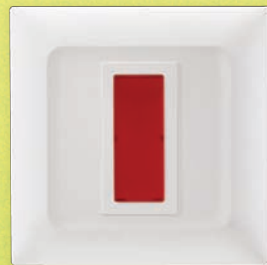

Flat Indicator Red



Skirting Light - 2M



16A Power Unit for
AC/ Geyser

INSTALLATION PROCESS

Installing a sensible switch is a simple process.
Here's how:



Fix the metal box either
into or on the wall.

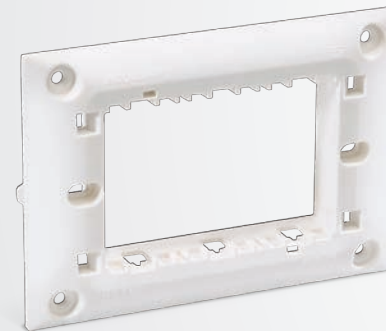

Press-fit the switch and
socket into the base frame.

Connect the wires
to the switch and socket.



Fix the connected and wired base frame to the metal box.

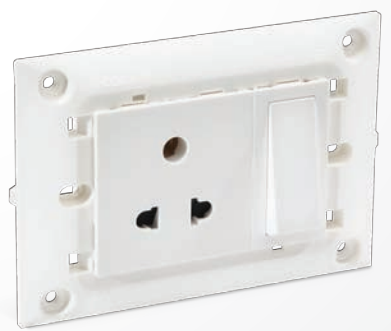



For a smooth and seamless look, press-fit the cover plate to the base frame.

ELVIRA

A SENSIBLE SWITCH

Switches

	Cat. Nos.	Description	Module	Pack	MRP ₹ / Unit
	800100	6A 1 way Switch	1	1/20/200	45

	Cat. Nos.	Description	Module	Pack	MRP ₹ / Unit
	800101	6A 2 way Switch	1	1/20/100	68

	Cat. Nos.	Description	Module	Pack	MRP ₹ / Unit
	800102	6A 1 way Switch with Indicator	1	1/20/200	70

	Cat. Nos.	Description	Module	Pack	MRP ₹ / Unit
	800103	16A 1 way Switch	1	1/20/200	92

	Cat. Nos.	Description	Module	Pack	MRP ₹ / Unit
	800104	16A 2 way Switch	1	1/10/100	114

	Cat. Nos.	Description	Module	Pack	MRP ₹ / Unit
	800105	16A 1 way Switch with Indicator	1	1/20/200	102

	Cat. Nos.	Description	Module	Pack	MRP ₹ / Unit
	800106	25A 1 way Switch with Indicator	1	1/10/100	147

	Cat. Nos.	Description	Module	Pack	MRP ₹ / Unit
	800107	20A DP Switch	2	1/10/50	143

	Cat. Nos.	Description	Module	Pack	MRP ₹ / Unit
	800108	32A DP Switch	2	1/10/50	197

	Cat. Nos.	Description	Module	Pack	MRP ₹ / Unit
	800122	6/16A 3 Pin Socket	2	1/10/50	129

	Cat. Nos.	Description	Module	Pack	MRP ₹ / Unit
	800110	6A Bell Push with Indicator-1M	1	1/20/200	74

	Cat. Nos.	Description	Module	Pack	MRP ₹ / Unit
	800124	25A 3 Pin Socket	2	1/10/50	144

	Cat. Nos.	Description	Module	Pack	MRP ₹ / Unit
	800111	6A Bell Push with Indicator-2M	2	1/10/100	115

	Cat. Nos.	Description	Module	Pack	MRP ₹ / Unit
	800123	Multistandard Socket 6/10/13A-250v	2	1/10/100	115

Sockets

	Cat. Nos.	Description	Module	Pack	MRP ₹ / Unit
	800120	6A 3 Pin Universal Socket	2	1/10/100	71

	Cat. Nos.	Description	Module	Pack	MRP ₹ / Unit
	800130	Telephone Socket -RJ11	1	1/20/100	68

	Cat. Nos.	Description	Module	Pack	MRP ₹ / Unit
	800121	10A Euro US Socket	1	1/20/100	69

	Cat. Nos.	Description	Module	Pack	MRP ₹ / Unit
	800131	Computer Socket -RJ45 Cat 6	1	1/20/100	195

ELVIRA

A SENSIBLE SWITCH

Electronic Products

	Cat. Nos.	Description	Module	Pack	MRP ₹ / Unit
	800140	Buzzer 230V	1	1/20/100	205

	Cat. Nos.	Description	Module	Pack	MRP ₹ / Unit
	800141	Fan Step Regulator 100W-1M	1	1/10/100	294

	Cat. Nos.	Description	Module	Pack	MRP ₹ / Unit
	800142	Fan Step Regulator 100W-2M	2	1/10/100	362

	Cat. Nos.	Description	Module	Pack	MRP ₹ / Unit
	800143	Light Dimmer 400W	1	1/10/100	290

	Cat. Nos.	Description	Module	Pack	MRP ₹ / Unit
	800154	Flat Indicator Red	1	1/20/100	87

TV Socket / Cable Outlet

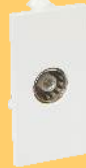
	Cat. Nos.	Description	Module	Pack	MRP ₹ / Unit
	800132	TV Socket	1	1/20/100	65

	Cat. Nos.	Description	Module	Pack	MRP ₹ / Unit
	800153	Cable outlet	1	1/20/100	62

Power Unit - Pre wired

	Cat. Nos.	Description	Module	Pack	MRP ₹ / Unit
	800125	16A Power unit for AC & Geyser	4	1/1/5	294

Bell Call Indicator

	Cat. Nos.	Description	Module	Pack	MRP ₹ / Unit
	800144	Bell Call Indicator	1	1/20/100	437

Motor Starter

	Cat. Nos.	Description	Module	Pack	MRP ₹ / Unit
	800196	25A Motor Starter	2	1/10/50	343

Skirting Light

	Cat. Nos.	Description	Module	Pack	MRP ₹ / Unit
	800155	Skirting light -2M	2	1/5/25	302

Blank Plate

	Cat. Nos.	Description	Module	Pack	MRP ₹ / Unit
	800151	1 Module Blank	1	1/20/200	22

	Cat. Nos.	Description	Module	Pack	MRP ₹ / Unit
	800152	2 Module Blank	2	1/10/100	30

Modular Plate with support frame - White

	Cat. Nos.	Description	Module	Pack	MRP ₹ / Unit
	800161	1 Module Plate	1	1/10/100	42

	Cat. Nos.	Description	Module	Pack	MRP ₹ / Unit
	800162	2 Module Plate	2	1/10/100	42

ELVIRA

A SENSIBLE SWITCH

Modular Plate with support frame - White

	Cat. Nos.	Description	Module	Pack	MRP ₹ / Unit
	800163	3 Module Plate	3	1/10/100	54

	Cat. Nos.	Description	Module	Pack	MRP ₹ / Unit
	800164	4 Module Plate	4	1/10/100	59

	Cat. Nos.	Description	Module	Pack	MRP ₹ / Unit
	800166	6 Module Plate	6	1/5/50	78

	Cat. Nos.	Description	Module	Pack	MRP ₹ / Unit
	800167	8 Module Plate (Vertical)	8	1/5/25	105

	Cat. Nos.	Description	Module	Pack	MRP ₹ / Unit
	800168	8 Module Plate (Horizontal)	8	1/5/50	103

	Cat. Nos.	Description	Module	Pack	MRP ₹ / Unit
	800165	12 Module Plate	12	1/5/25	151

	Cat. Nos.	Description	Module	Pack	MRP ₹ / Unit
	800169	16 Module Plate	16	1/5/25	171

	Cat. Nos.	Description	Module	Pack	MRP ₹ / Unit
	800170	18 Module Plate	18	1/5/25	205

Metal Flush Box

	Cat. Nos.	Description	Module	Pack	MRP ₹ / Unit
	800172	Metal Flush Box -1/2 Module	1/2	1/0/40	56

	Cat. Nos.	Description	Module	Pack	MRP ₹ / Unit
	800173	Metal Flush Box -3 Module	3	1/0/40	77

	Cat. Nos.	Description	Module	Pack	MRP ₹ / Unit
	800174	Metal Flush Box -4 Module	4	1/0/40	91

	Cat. Nos.	Description	Module	Pack	MRP ₹ / Unit
	800176	Metal Flush Box -6 Module	6	1/0/40	149

	Cat. Nos.	Description	Module	Pack	MRP ₹ / Unit
	800177	Metal Flush Box -8 Module(V)	8	1/0/20	191

	Cat. Nos.	Description	Module	Pack	MRP ₹ / Unit
	800178	Metal Flush Box -8 Module(H)	8	1/0/40	191

	Cat. Nos.	Description	Module	Pack	MRP ₹ / Unit
	800175	Metal Flush Box -12 Module	12	1/0/10	256

	Cat. Nos.	Description	Module	Pack	MRP ₹ / Unit
	800179	Metal Flush Box -16 Module	16	1/0/10	292

	Cat. Nos.	Description	Module	Pack	MRP ₹ / Unit
	800180	Metal Flush Box -18 Module	18	1/0/10	316

Surface Box

	Cat. Nos.	Description	Module	Pack	MRP ₹ / Unit
	800182	Plastic Surface Box 1/2 Module	1/2	1/0/50	67

ELVIRA

A SENSIBLE SWITCH

Surface Box

	Cat. Nos.	Description	Module	Pack	MRP ₹ / Unit
	800183	Plastic Surface Box -3 Module	3	1/0/35	84

	Cat. Nos.	Description	Module	Pack	MRP ₹ / Unit
	800184	Plastic Surface Box -4 Module	4	1/0/25	99

	Cat. Nos.	Description	Module	Pack	MRP ₹ / Unit
	800186	Plastic Surface Box -6 Module	6	1/0/10	149

	Cat. Nos.	Description	Module	Pack	MRP ₹ / Unit
	800187	Plastic Surface Box -8 Module(V)	8	1/0/15	212

	Cat. Nos.	Description	Module	Pack	MRP ₹ / Unit
	800188	Plastic Surface Box -8 Module(H)	8	1/0/10	207

	Cat. Nos.	Description	Module	Pack	MRP ₹ / Unit
	800185	Plastic Surface Box -12 Module	12	1/0/10	255

	Cat. Nos.	Description	Module	Pack	MRP ₹ / Unit
	800189	Plastic Surface Box -16 Module	16	1/0/10	306

	Cat. Nos.	Description	Module	Pack	MRP ₹ / Unit
	800190	Metal Surface Box -18 Module	18	1/0/10	323

WARRANTY

Elvira products ensure a warranty against manufacturing defects, subject to use of the product for the right application, with correct wiring/ connection and normal operating conditions. Please refer to detailed IndoAsian warranty policy effective 1st January 2016.

For all Switches & Sockets: 10 Years

For all Electronic Products: 2 Years

(e.g. Fan Regulator, Dimmer, Buzzer, RJ45, RJ11, TV Sockets, Bell Call Indicator, Motor Starter, Skirting Light & Indicator)

ELVIRA

A SENSIBLE SWITCH

Cover Plates

1 module
800161

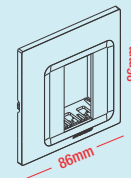

2 module
800162

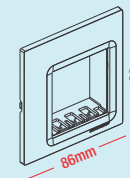

3 module
800163

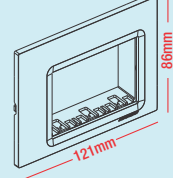

Flush Boxes-Metal

1 & 2 module
800172

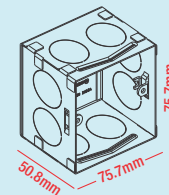

3 module
800173

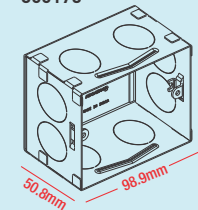

4 module
800174

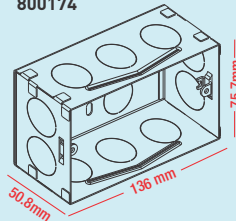

Surface Boxes

1 & 2 module
800182

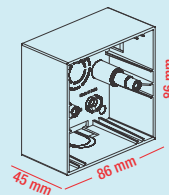

3 module
800183

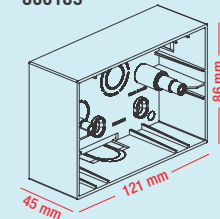

4 module
800184

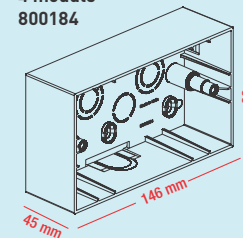

4 module
800164

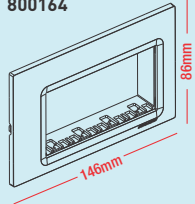

6 module
800166

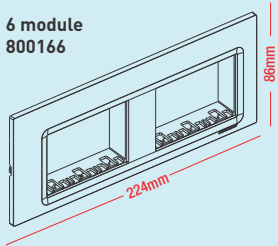

8 module (Horizontal)
800168

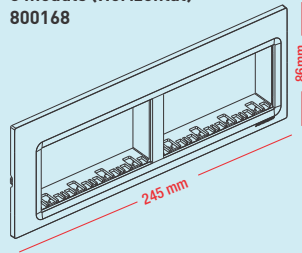

8 module (Vertical)
800167

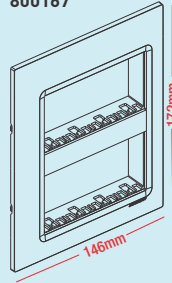

12 module
800165

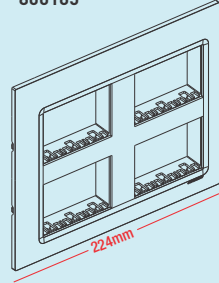

16 module
800169

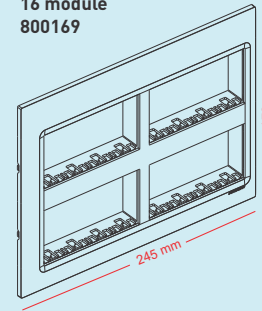

18 module
800170

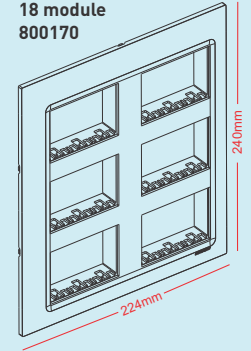

6 module
800176

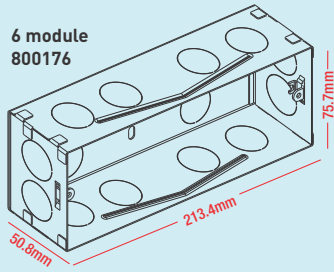

8 module (Horizontal)
800178

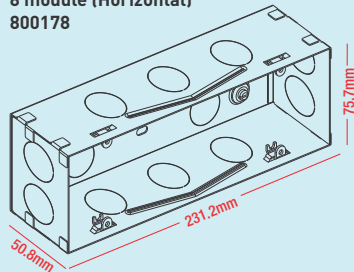

8 module (Vertical)
800177

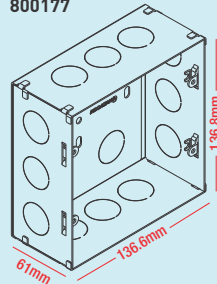

12 module
800175

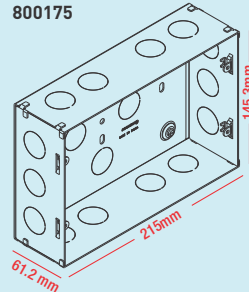

16 module
800179

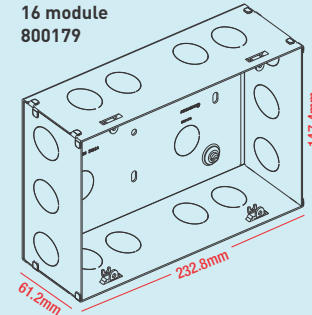

18 module
800180

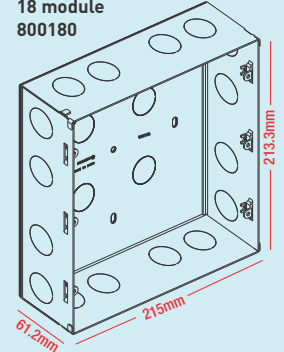

6 module
800186

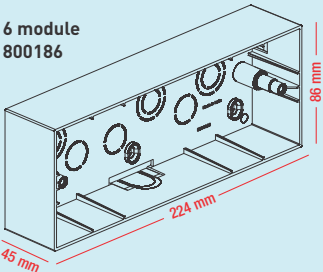

8 module (Horizontal)
800188

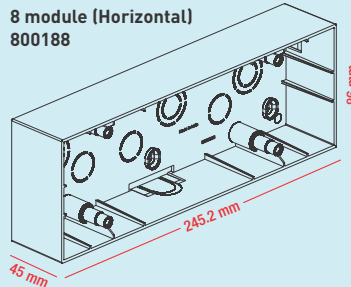

8 module (Vertical)
800187

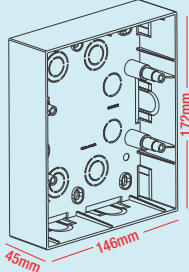

12 module
800185

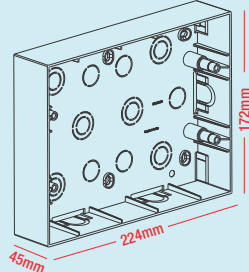

16 module
800189

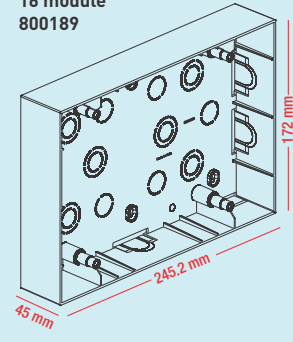

18 module
800190

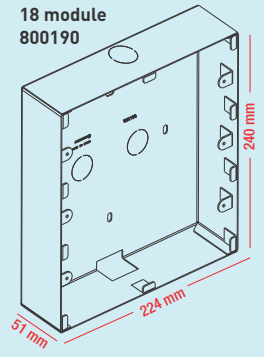

CORPORATE OFFICE:

B-24, Phase - II, Noida - 201305, U.P., India
Ph.: +91-120-3853000 Fax: +91-120-3853002
E-mail: sales@indoasian.com, international@indoasian.com
Website: www.indoasian.com

CUSTOMER CARE SUPPORT EXECUTIVE:

B-24, Phase - II, Noida - 201305, U.P., India
Ph.: +91-120-3042222
E-mail: feedback@indoasian.com

NORTH

CHANDIGARH

S.C.O.-11, 2nd Floor,
Madhya Marg, Sector-26,
Chandigarh-160002
Ph.: 0172-3934651-64
Telefax: 0172-3934656
E-Mail: in-chandigarh-office@indoasian.com

DELHI

721-722, 7th Floor,
DLF Tower B,
Jasola District Centre,
New Delhi-110044
Ph.: 011-30821773-74
E-Mail: in-delhi-office@indoasian.com

JAIPUR

433, Ganpati Plaza,
M. I. Road,
Jaipur-302001
Ph.: 0141-4113528
E-Mail: in-jaipur-office@indoasian.com

LUCKNOW

301, Chintel House, Station Road,
Lucknow-226001
Ph.: 0522-4013210
TeleFax: 0522-4013210
E-Mail: in-lucknow-office@indoasian.com

SOUTH

BANGALORE

402, 4th Floor, Blue Cross Chambers,
Infantry Road Cross,
Bangalore-560001
Ph.: 080-25585043, 25591677
Fax: 080-25591546
E-Mail: in-bangalore-office@indoasian.com

COCHIN

Door No. 65/1317,
Syda Building, 2nd Floor,
Kaloor-Kadavanthra Road, Kaloor,
Ernakulam District, Kochi-682017 (Kerala)
Ph.: 0484-4055581-88
E-Mail: in-cochin-office@indoasian.com

COIMBATORE

D. No. 83, Dr. Nanjappa Road,
Coimbatore-641018
Ph.: 0422-2302715
Fax: 0422-2302715
E-Mail: in-coimbatore-office@indoasian.com

CHENNAI

No. 5, Mahalingapuram Main Road,
Nungambakkam,
Chennai-600034
Ph.: 044-28172096, 28170527
E-Mail: in-chennai-office@indoasian.com

HYDERABAD

312, 3rd Floor, Amrutha Estates,
Himayath Nagar,
Hyderabad-500029
Ph.: 040-66742425-29
E-Mail: in-secunderabad-office@indoasian.com

WEST

AHMEDABAD

Shivalik High Street,
Near Mansi Circle, Vastrapur,
Ahmedabad-380015
Ph.: 079-30002092-94
E-Mail: in-ahmedabad-office@indoasian.com

INDORE

202, K.K. Bafna Arcade,
Janjeerwala Square,
Racecourse Road,
Indore-401408
Ph.: 09713055522
E-Mail: in-indore-office@indoasian.com

MUMBAI

401 & 408, K.P. Arrum,
Marol Maroshi Road, Andheri East,
Mumbai-400059
Ph.: 022-61035800
E-Mail: in-mumbai-office@indoasian.com

PUNE

Rajadwar Building, 4th Floor,
1307, Shivaji Nagar, Off. J.M. Road,
Pune-411005
Ph.: 020-60500440, 60502255
Fax: 020-25520659
E-Mail: in-pune-office@indoasian.com

EAST

KOLKATA

Raikva Building, Room No. 8, 2nd Floor,
3A Ram Mohan Garden Lane,
Beliaghata E.M.Bypass, Kolkata-700010
Ph.: 033-66041503-04
E-Mail: in-kolkata-office@indoasian.com